

Návod na montáž rámu výklopné postele - 180 vystužené lamely

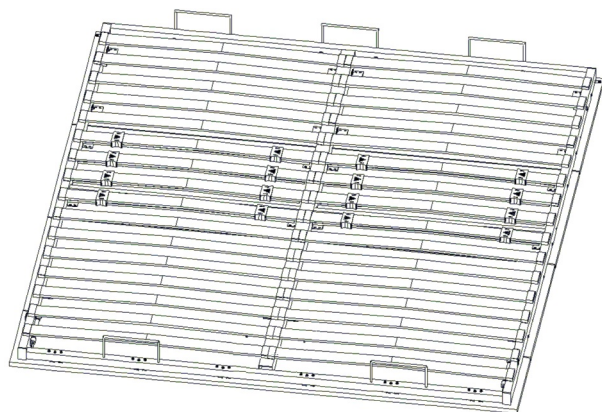

Šroub ozdobný 4x60 6x 	Šroub ozdobný 4x40 12x 	Šroub zápusťný 3x35 18x 	Úchyt dveří 50x40x20mm 24x
Podložka M4 24x 	Podložka M3 18x 	Matice samojistná M4 18x 	Matice samojistná M3 18x
Koncovka 50x30 4x 	Pant 60mm 6x 	Držák lamel 60x 	Lamely 885mm 30x
		Lamely 825mm 8x 	Lamelová objímka 16x

1. Rám boční pohled

Velmi důležité při montáži dodržet obsazení děr!

Varianta rámu 180: VS 1054, VS 3054

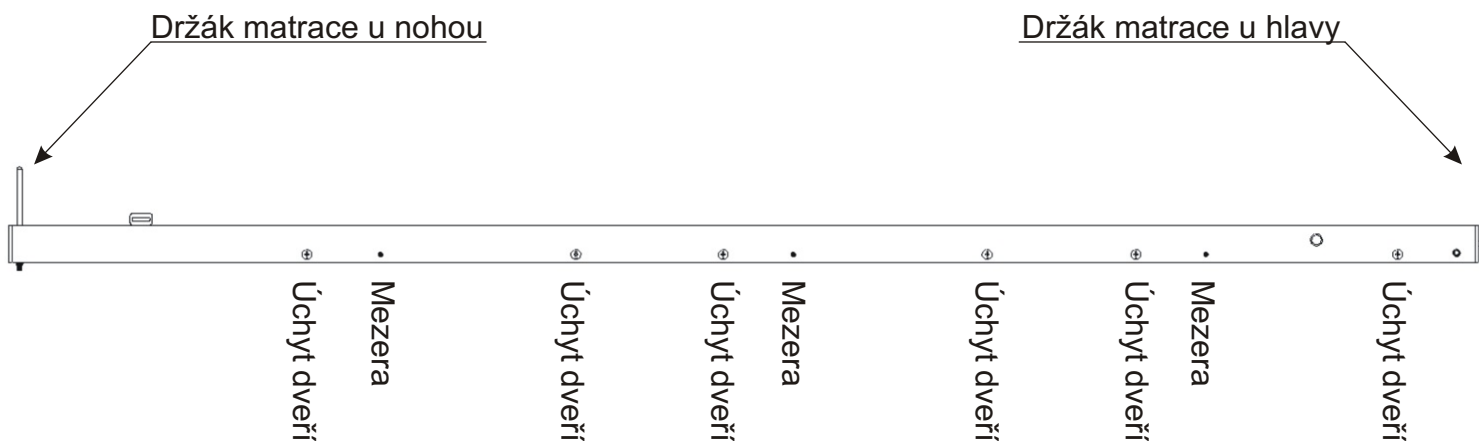

Varianta rámu VS 180: 21058,21075,3075,4070

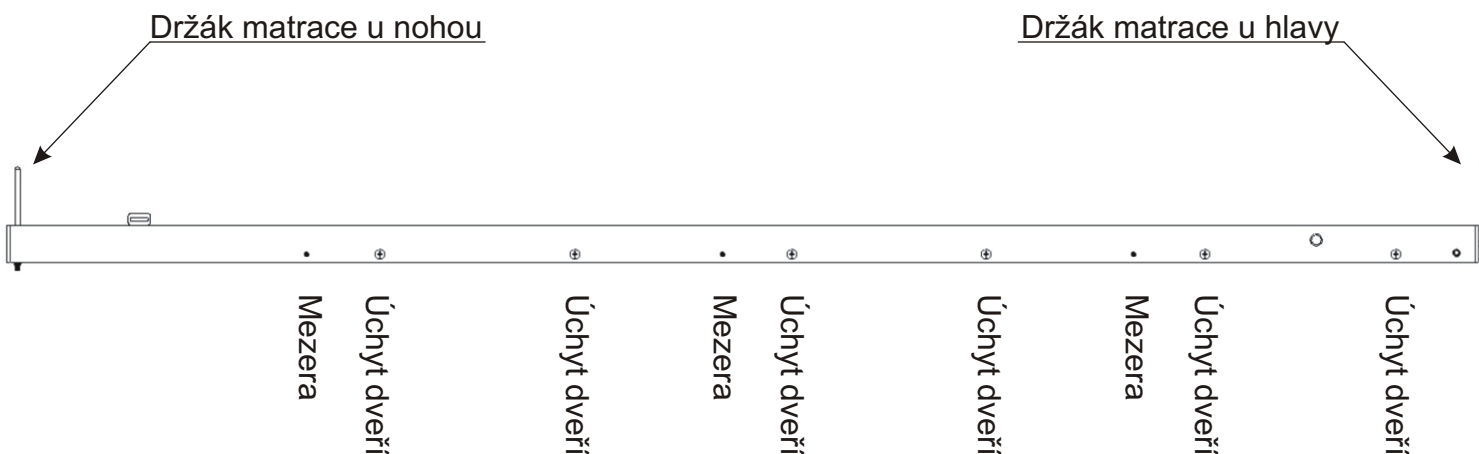

2.Nasazení panty

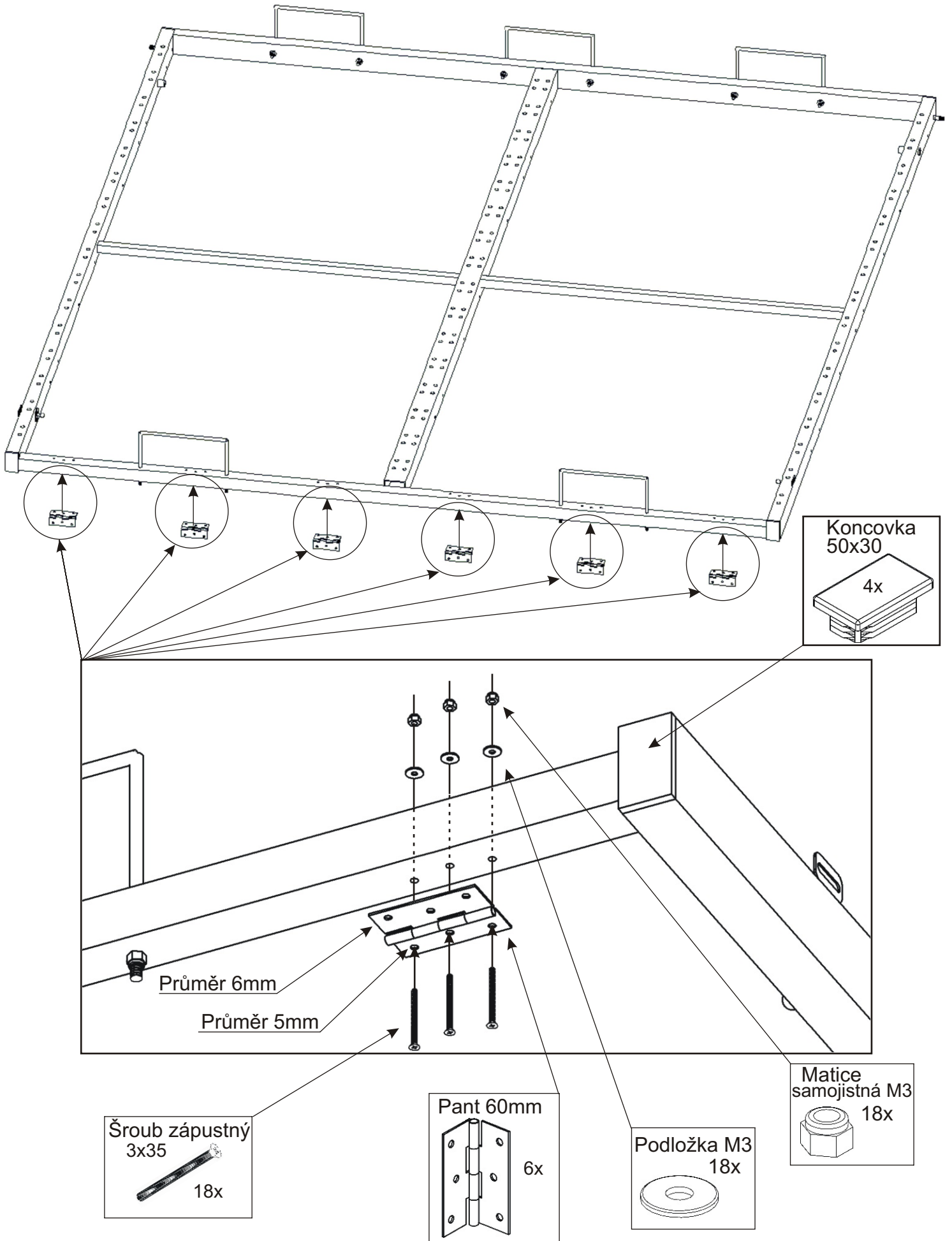

3. Držáky dveří

Matice
samojistná M4
6x



Podložka M4
12x

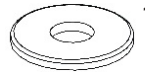

Úchyt dveří
50x40x20mm
12x

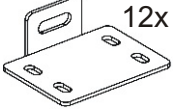

Šroub ozdobný
4x60
6x

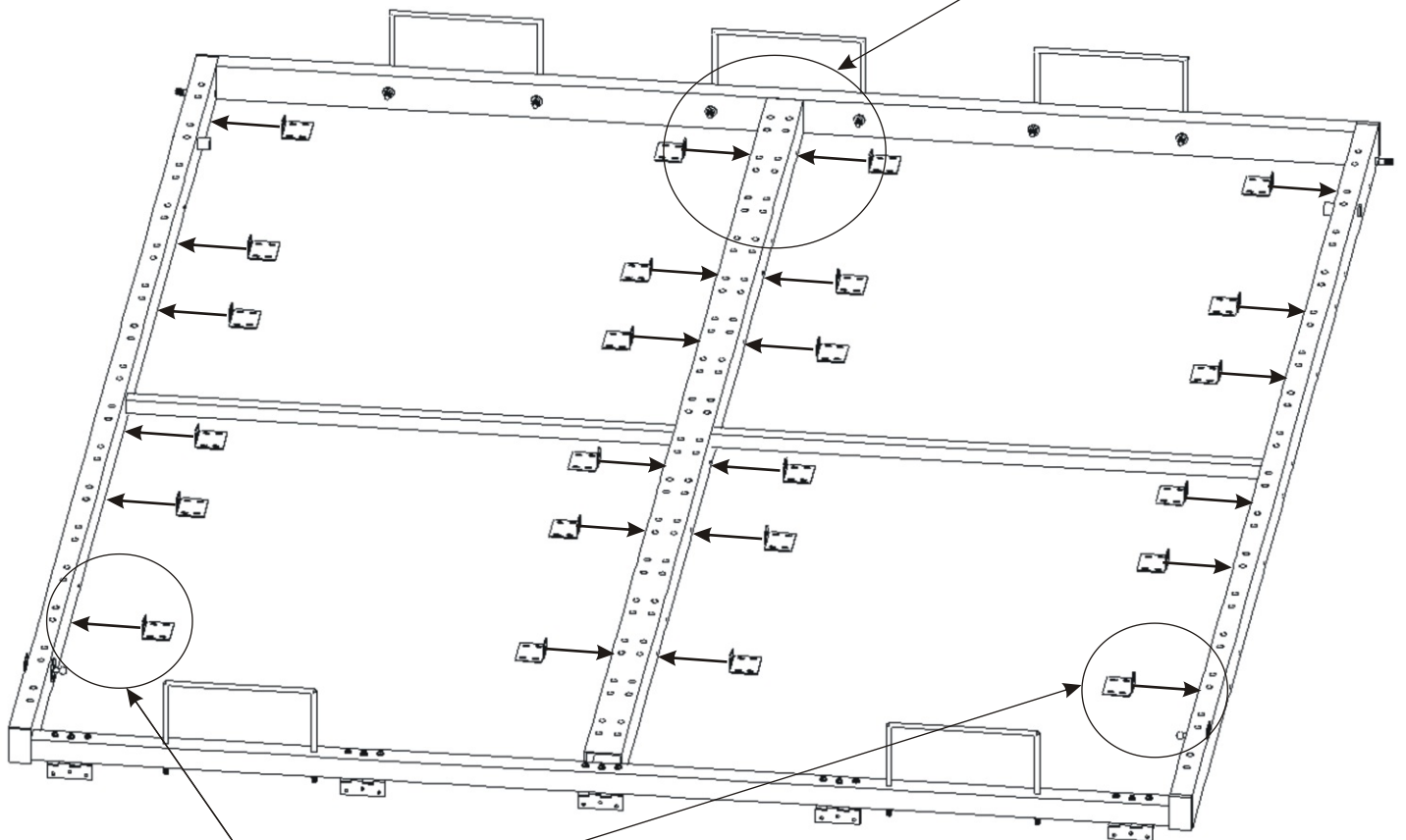
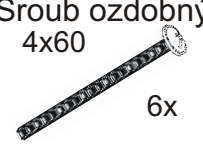

Šroub ozdobný
4x40
12x



Úchyt dveří
50x40x20mm
12x

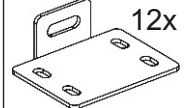

Podložka M4
12x

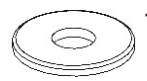

Matice
samojistná M4
12x



4. Nasazení lamel

Držáky natlučeme z obou stran na lamely

Lamely nasadíme až ke konci návodu na montáž kompletní výklopné postele!

Držák lamel
44x

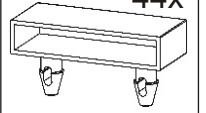

4.1.

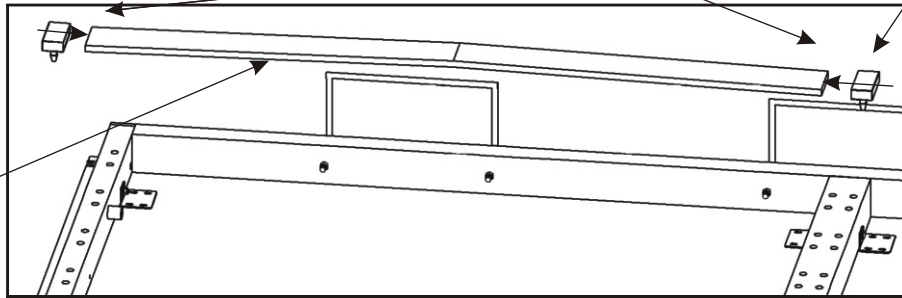

4.2.

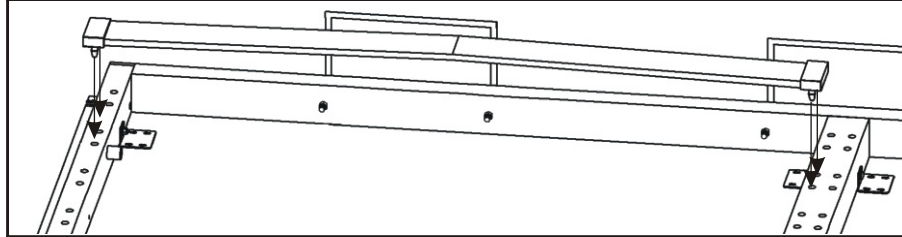

4.3.

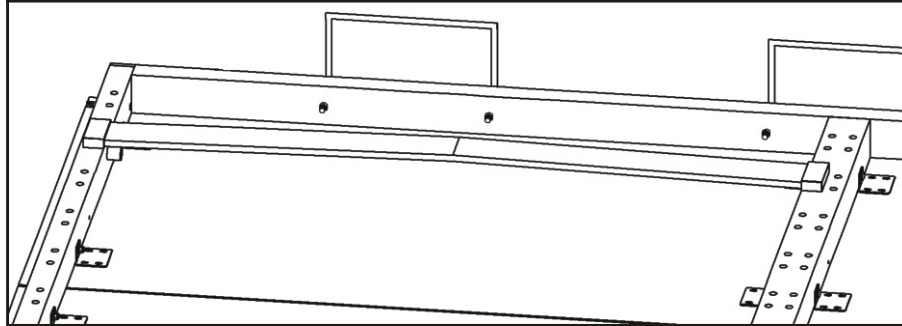

Lamely
885mm



22x

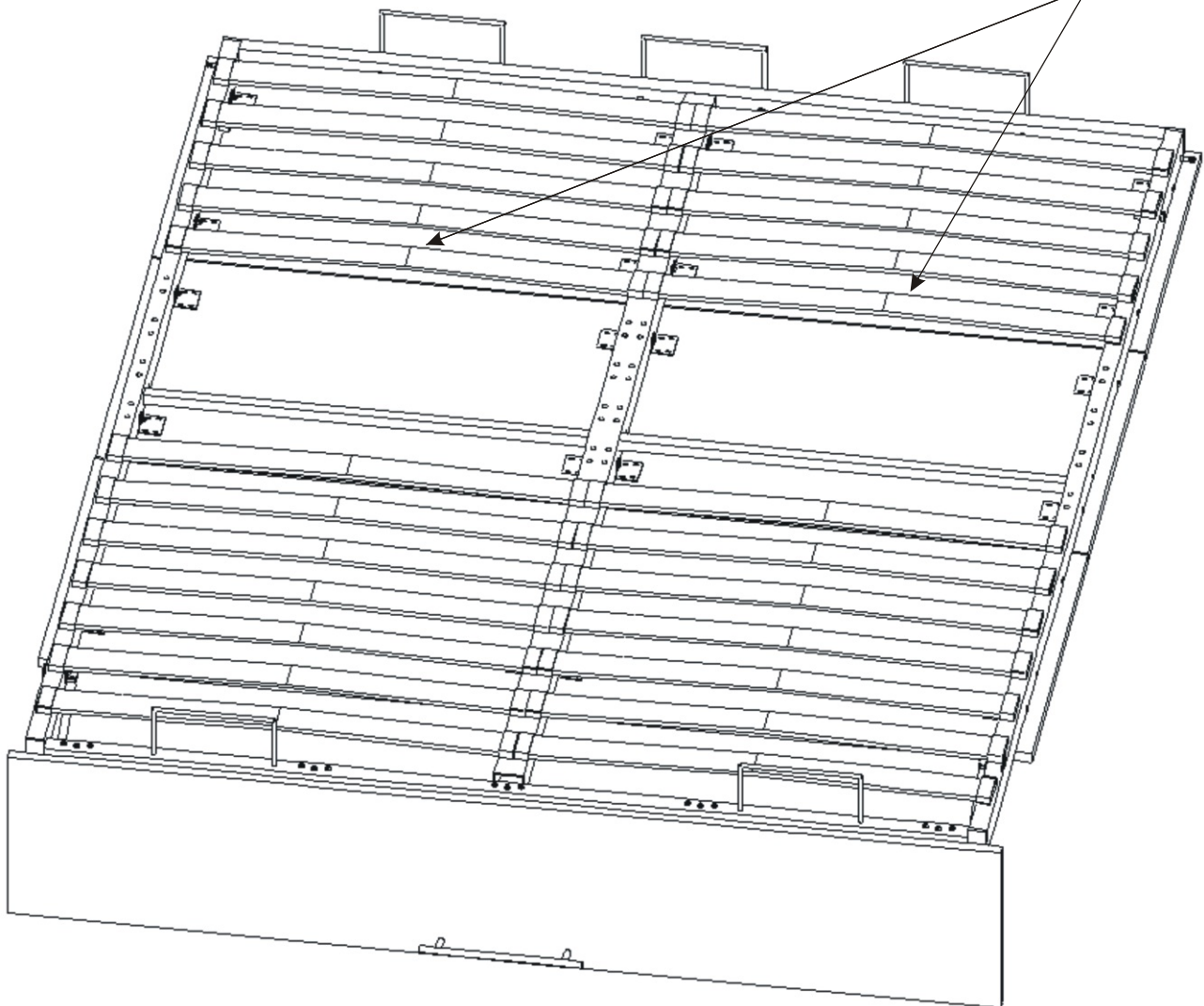

5. Nasazení vystužených lamel

Lamely
885mm

8x

Lamely
825mm

8x

Lamelová
objímka

16x

Držák lamel
16x

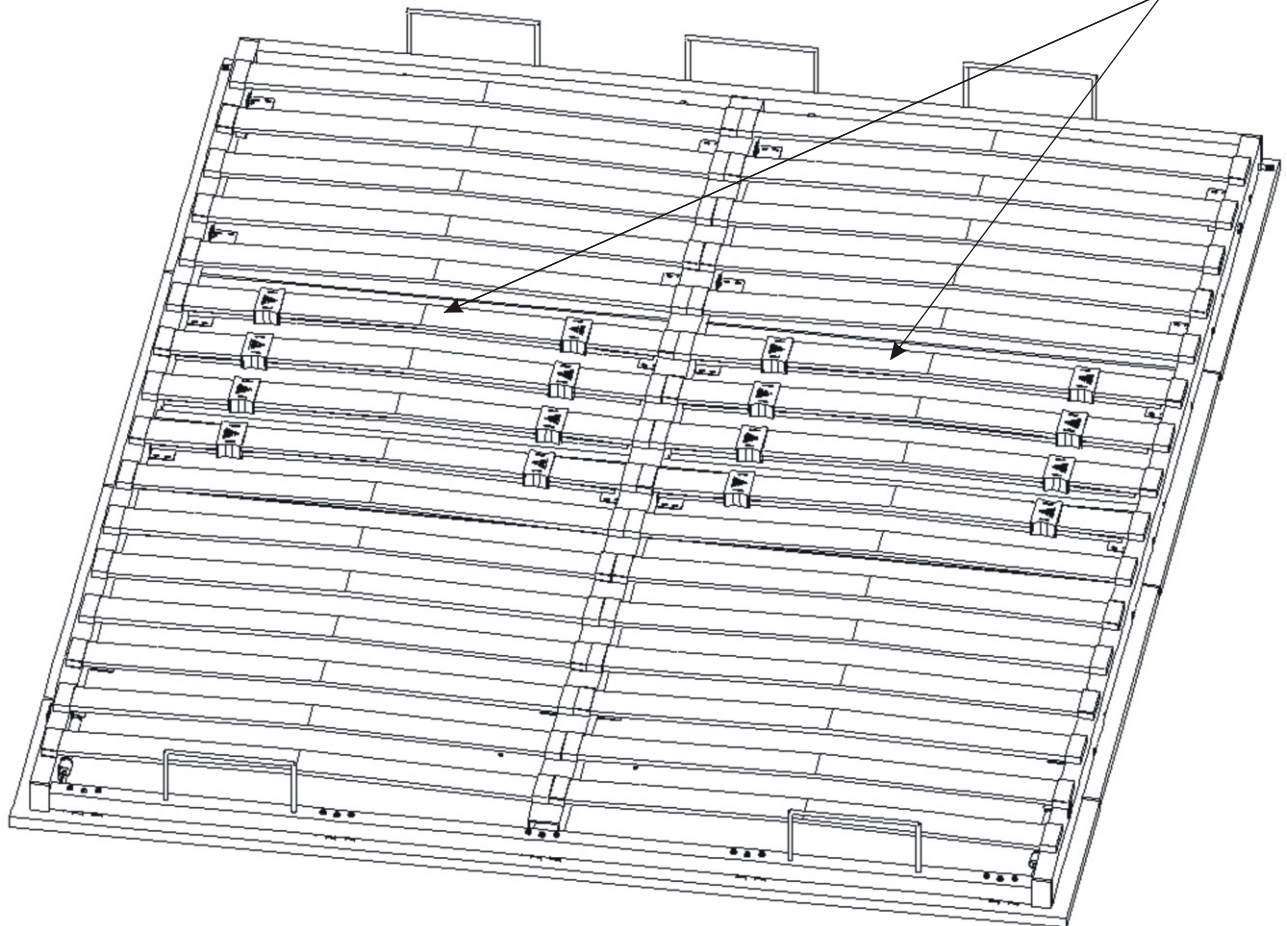
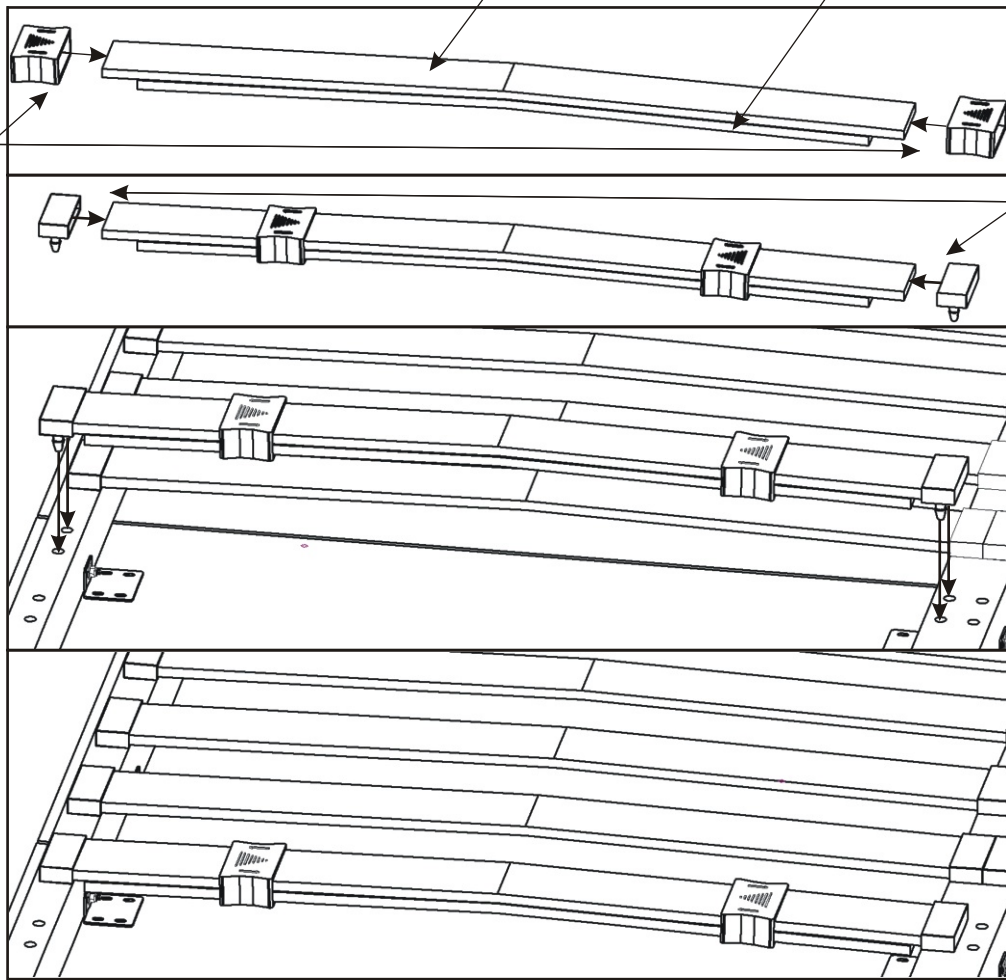

6. Nastavení tuhosti lamel v oblasti bederní opory páteře

