

# ALFA 185

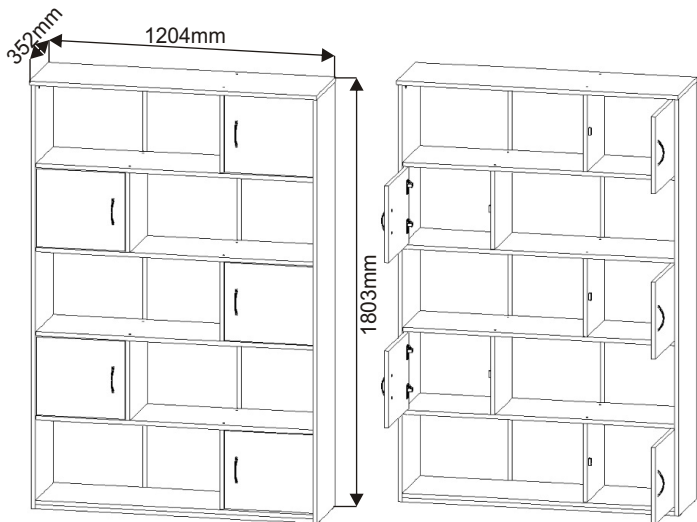

<b>Úchytka 96mm</b> 5x 10x 4x22mm	<b>Vložený pant s tlumením</b> 10x	<b>Úhelník 73x31x15</b> 2x	<b>Excentr</b> 16x	<b>Šroub excentru</b> 16x	<b>Zarážka dveří</b> 5x
<b>Kolík 35mm</b> 36x	<b>Lepidlo 40ml</b> 1x	<b>Konfirmát 50mm</b> 20x	<b>Hmoždinka ø10</b> 2x	<b>Hřebík</b> 132x	<b>Krytka velká</b> 30x
<b>Kluzáky</b> 6x	<b>Vrut 3,5x16</b> 10x	<b>Vrut 4x16</b> 40x	<b>Vrut 4x20</b> 4x	<b>Vrut 4x30</b> 8x	<b>Vrut 5x50</b> 2x
					<b>H lišta 334mm</b> 5x

1.

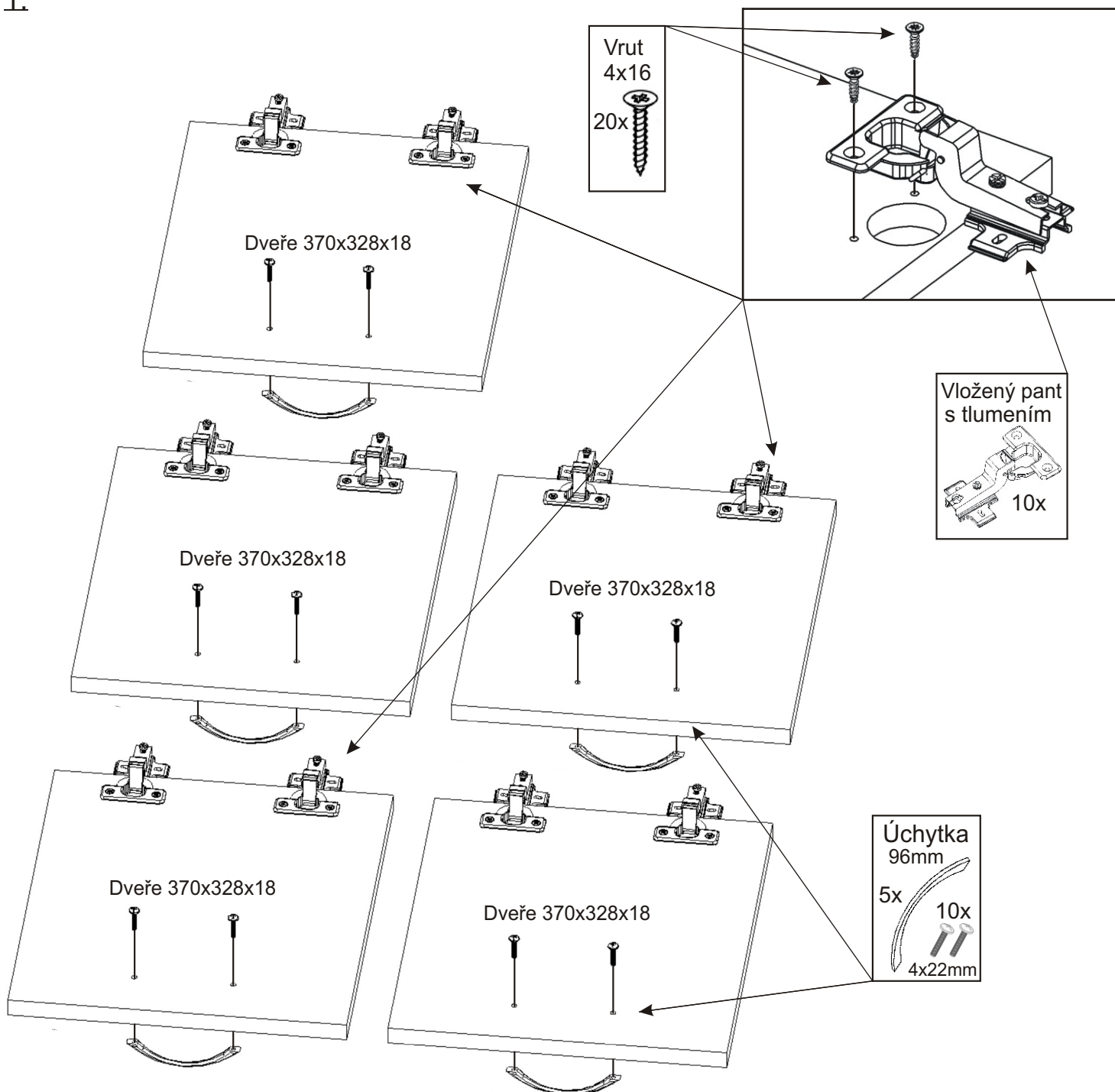

2.

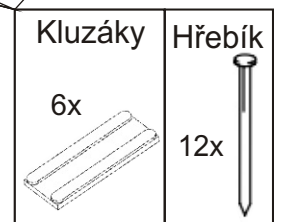
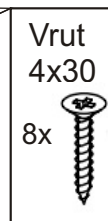
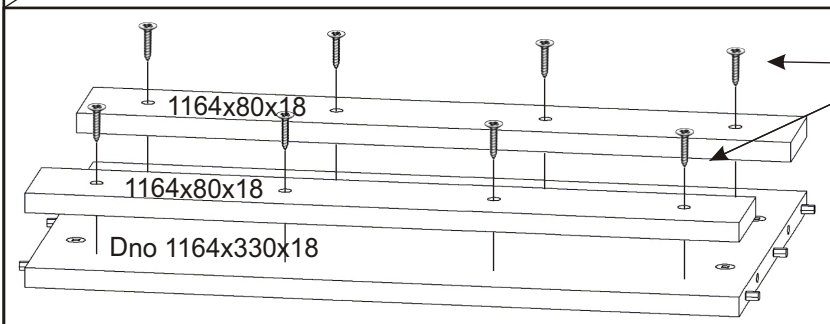
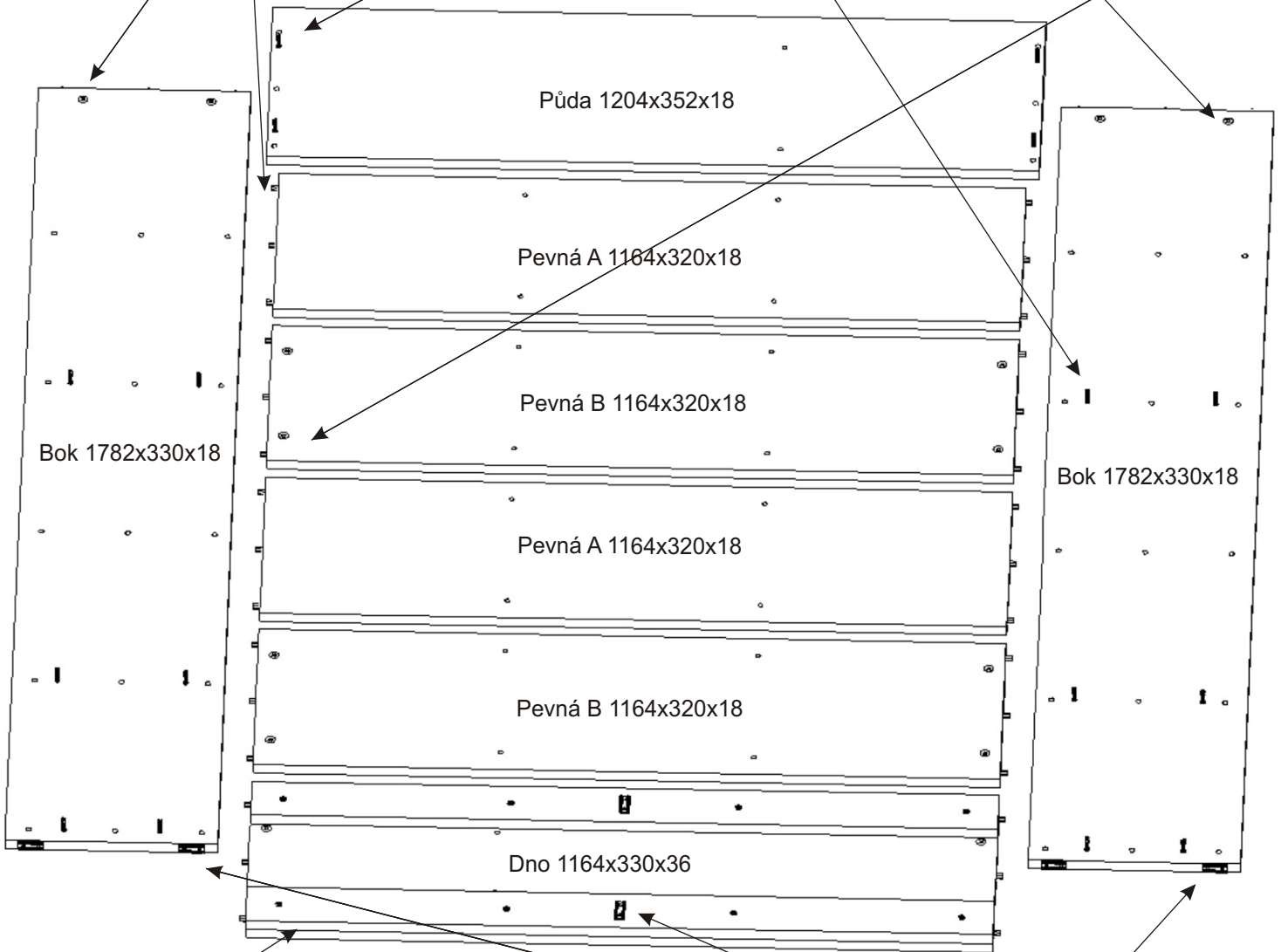
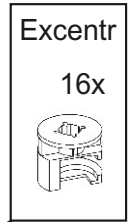
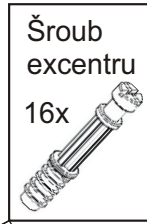
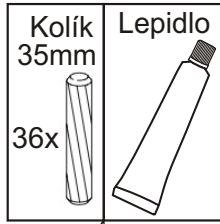

3.

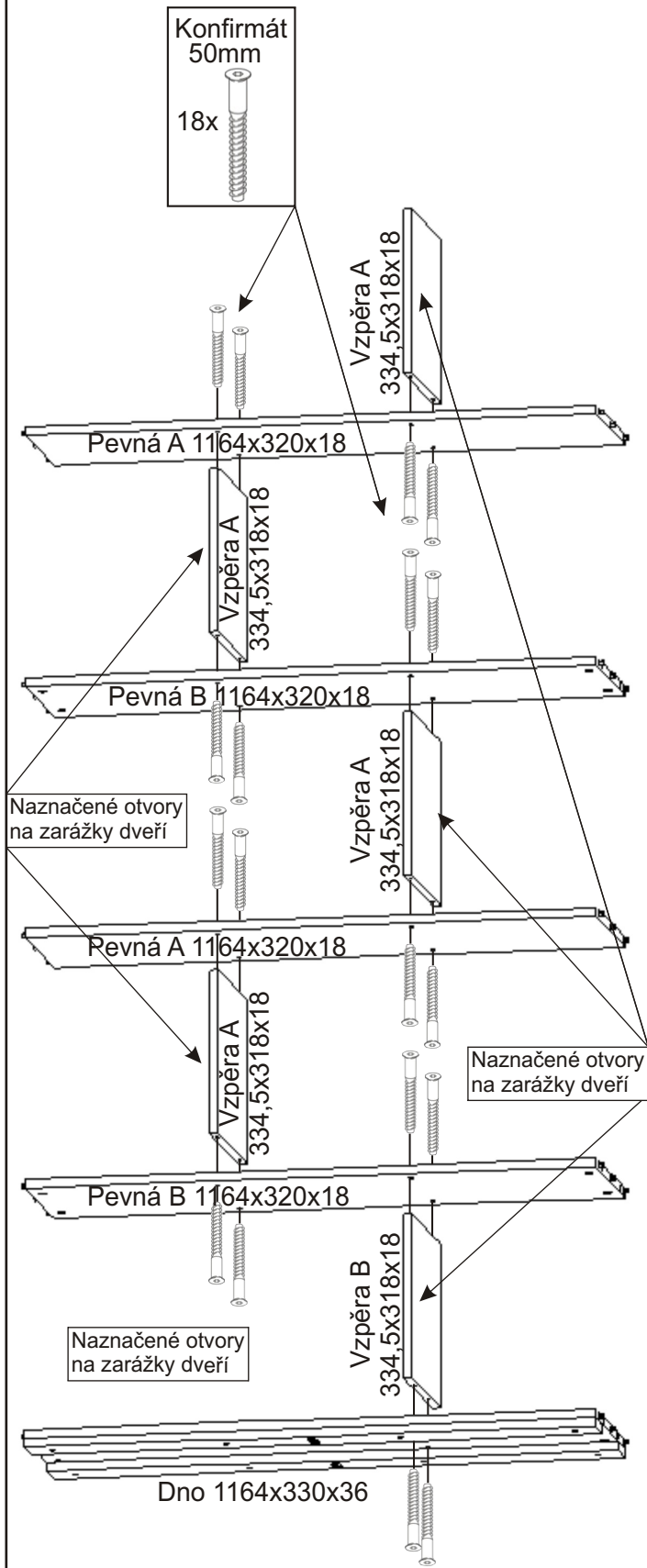

4.

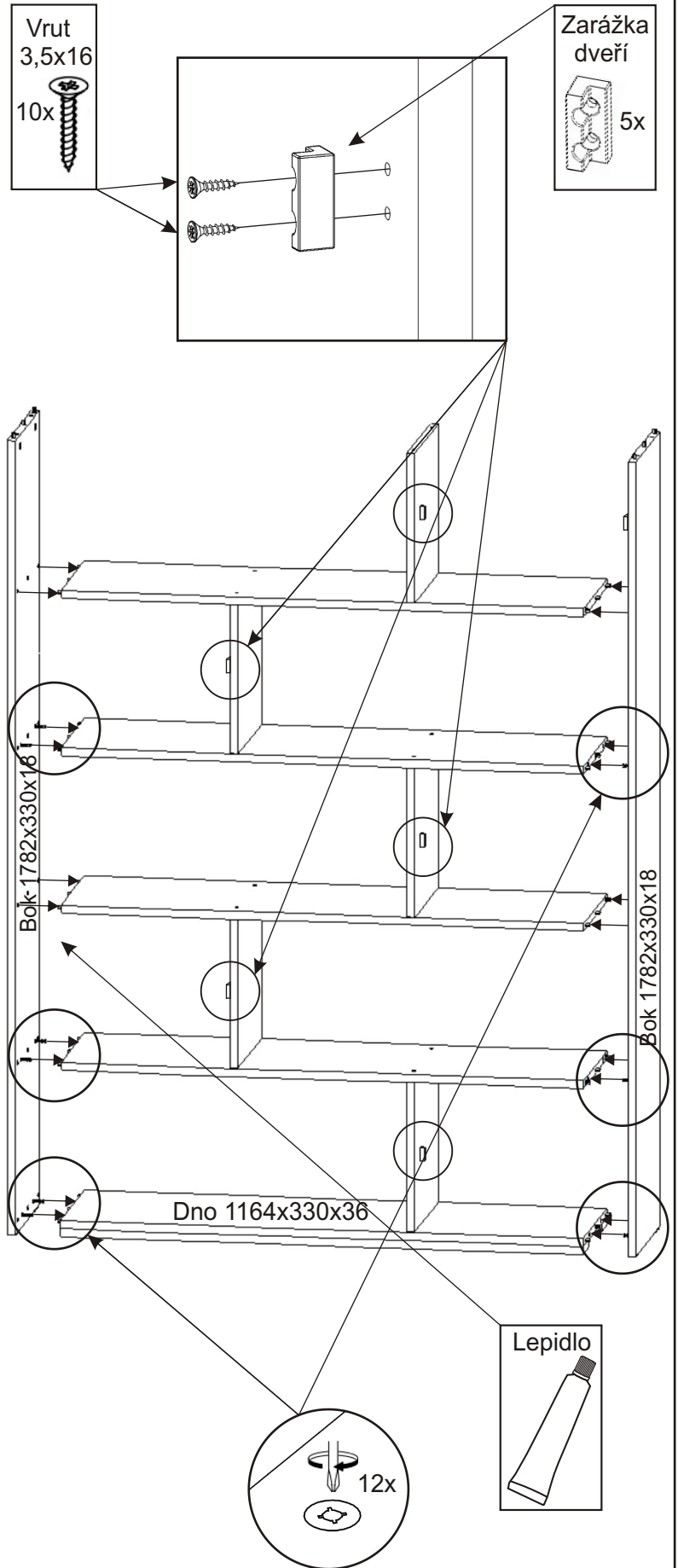

5.

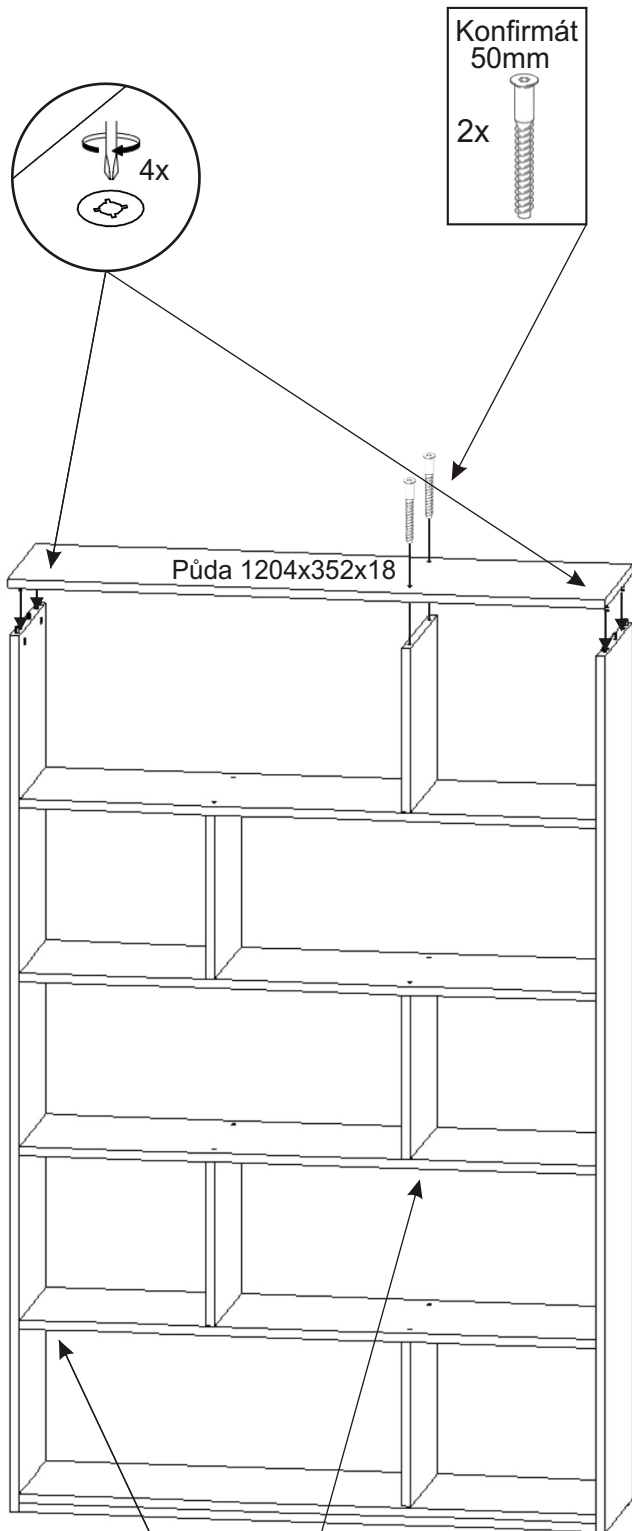

6.

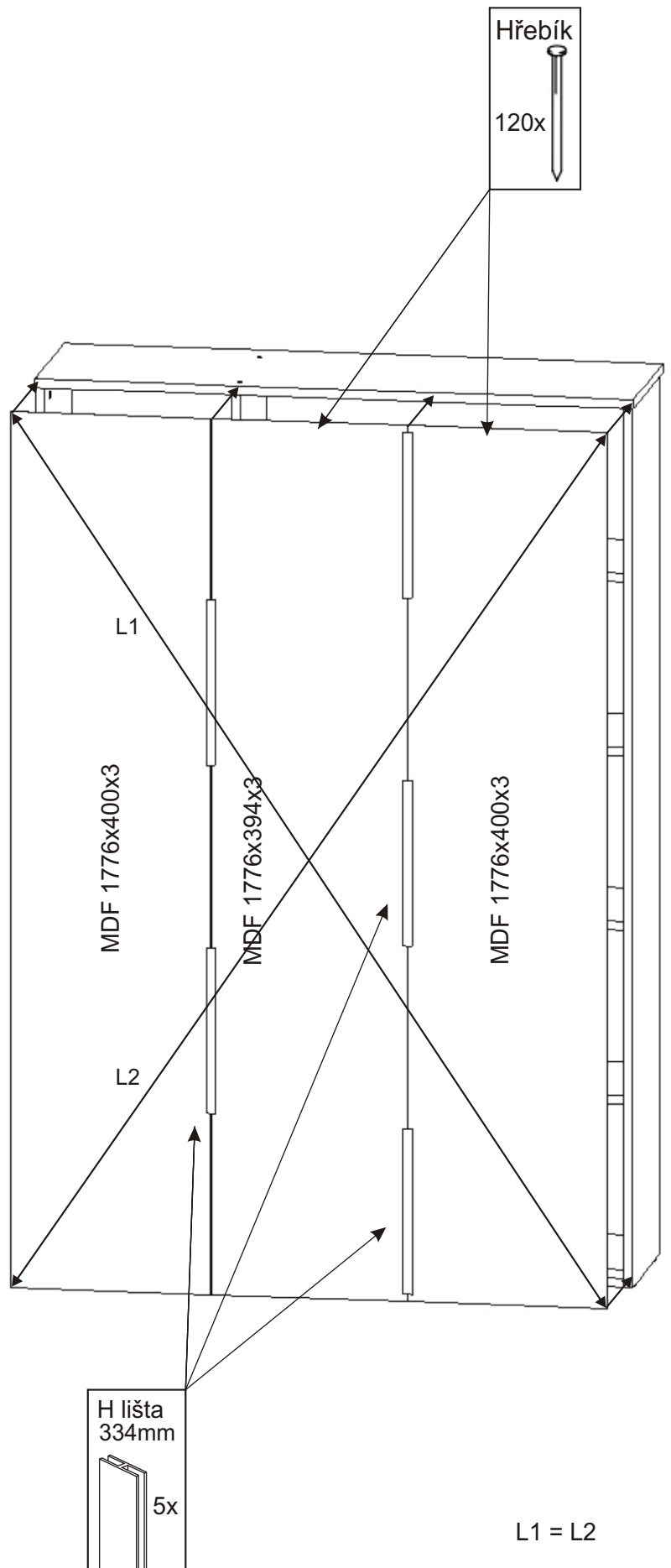

7.

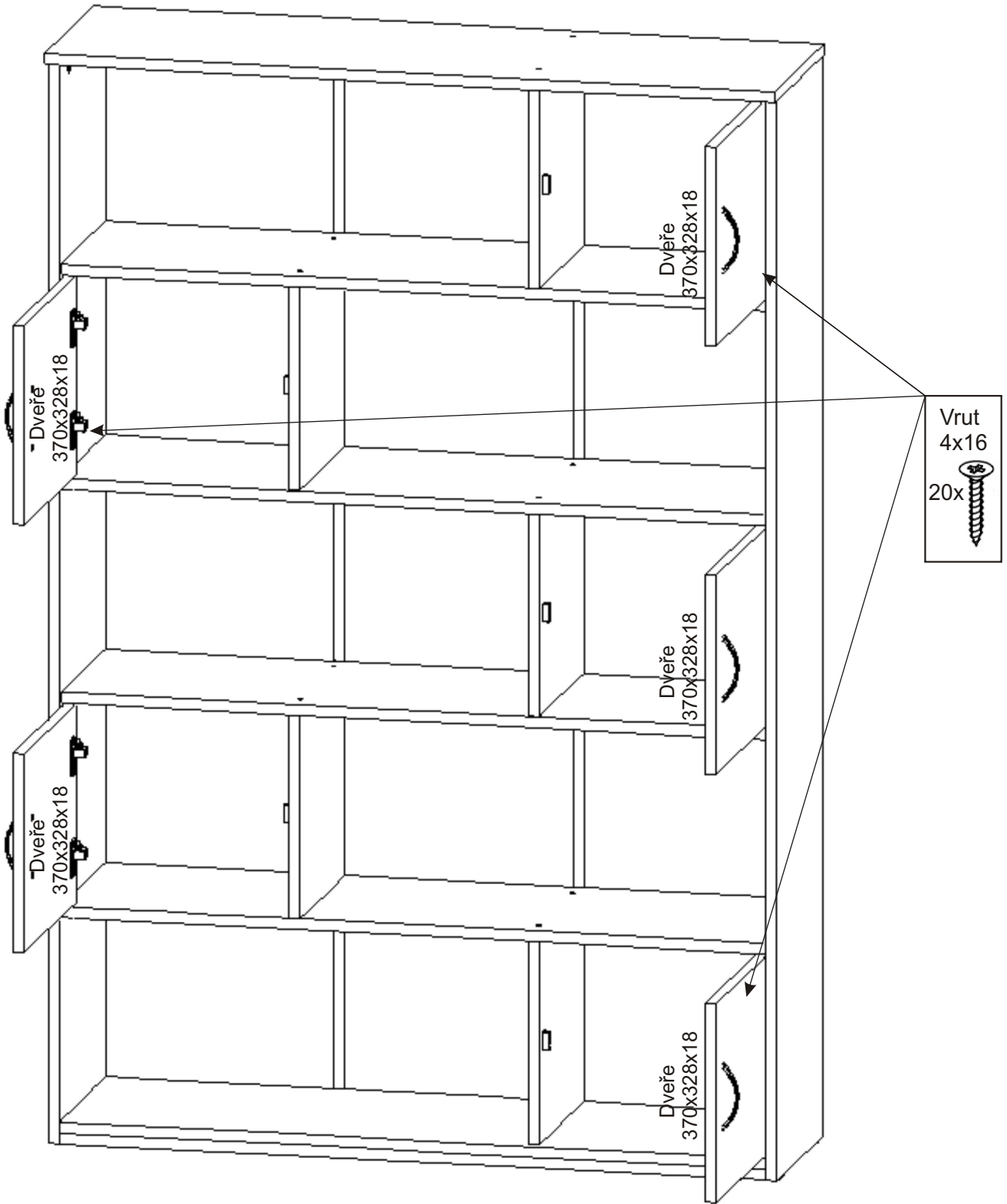

8.

Skříň doporučujeme kvůli nebezpečí převržení připevnit ke zdi pomocí úhelníků. Skříň přisuneme ke zdi na místo kde bude umístěna a označíme otvory pro hmoždinky. Navrtáme otvory pro hmoždinky a připevníme dodanými vruty. (Námi dodávané hmoždinky jsou vhodné pro stěny z plných materiálů.)

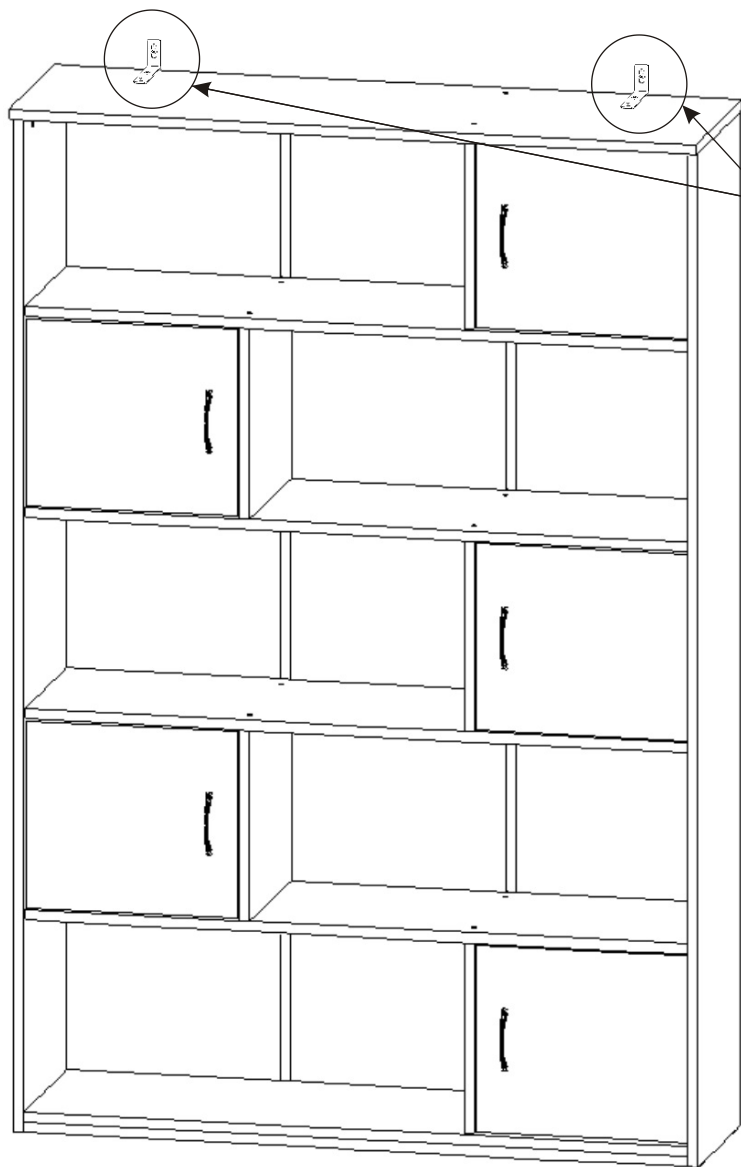

8.1.

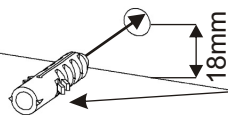

Hmoždinka

ø10

2x



Vrut  
4x20

4x



8.2.

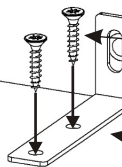

Úhelník  
73x31x15

2x

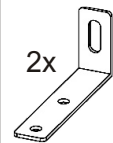

8.3.

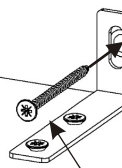

Vrut  
5x50

2x

