

ALFA 184

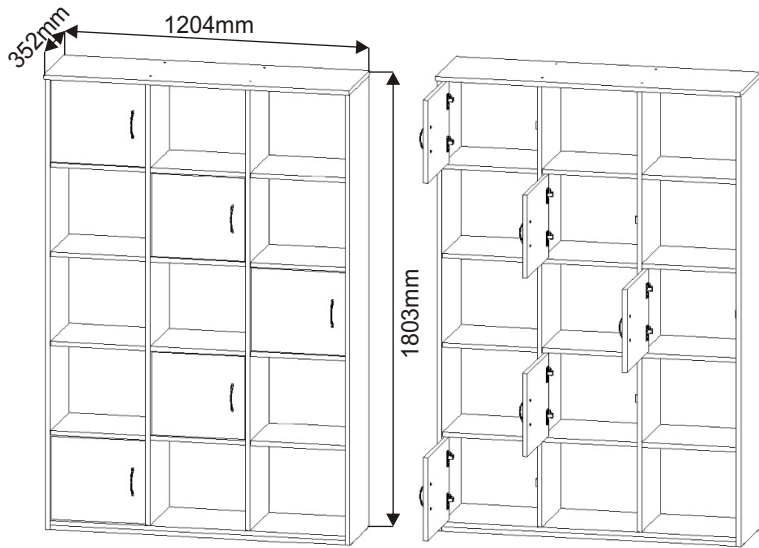

Úchytka 96mm 5x  10x  4x22mm	Vložený pant s tlumením 10x 	Úhelník 73x31x15 2x 	Excentr 24x 	Šroub excentru 24x 		
Kolík 35mm 60x 	Lepidlo 40ml 1x 20ml 1x 	Konfirmát 50mm 20x 	Hmoždinka ø10 2x 	Hřebík 132x 	Krytka velká 24x 	
Kluzáky 6x 	Zarážka dveří 5x 	Vrut 3,5x16 10x 	Vrut 4x16 40x 	Vrut 4x20 4x 	Vrut 4x30 8x 	Vrut 5x50 2x 

1.

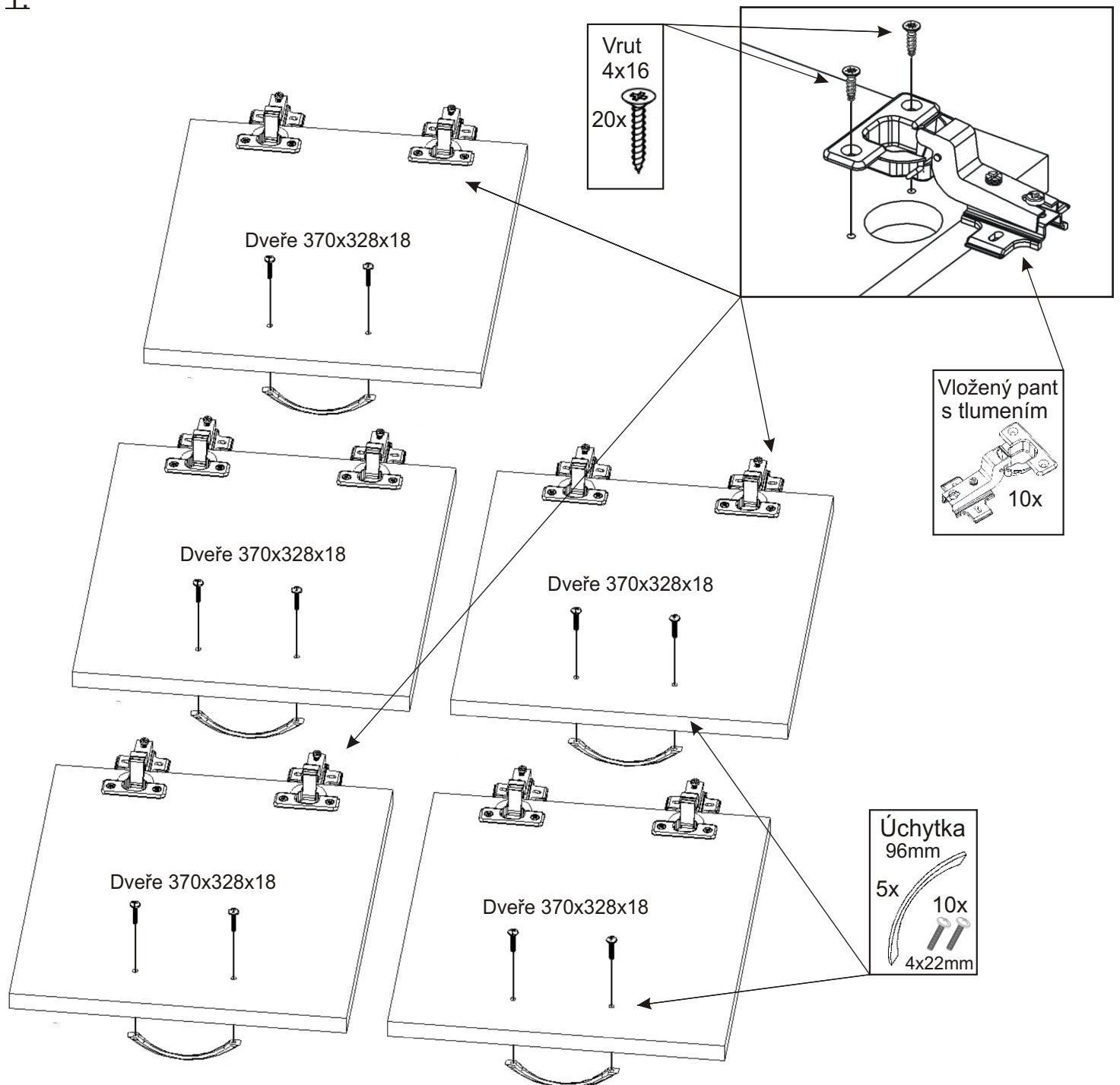

2.

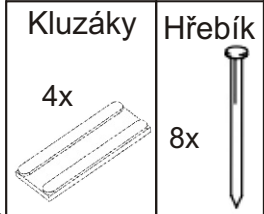
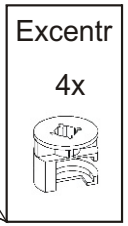
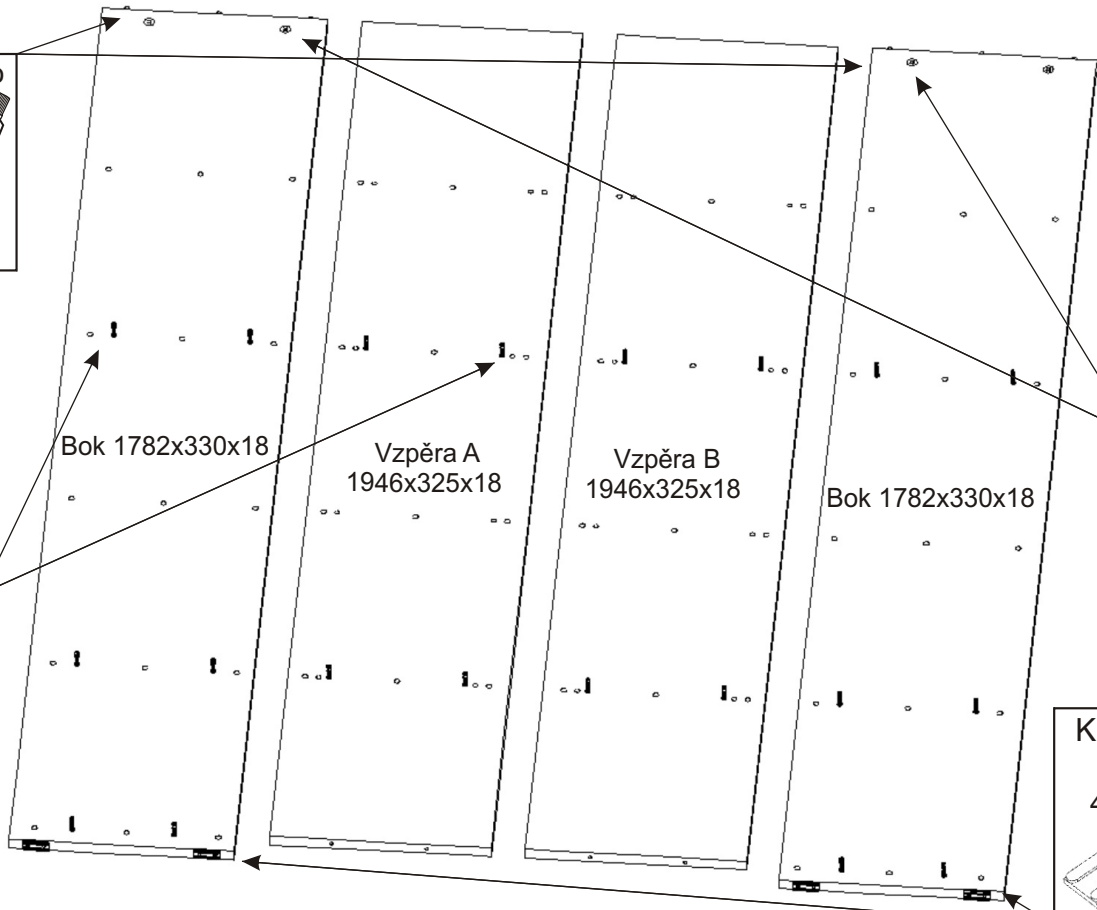
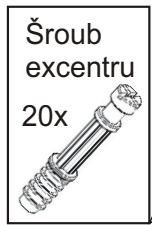
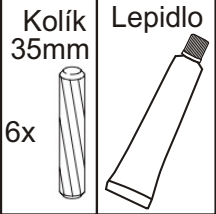

3.

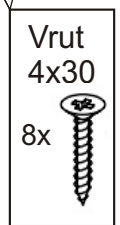
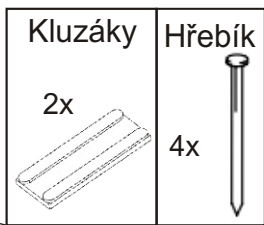
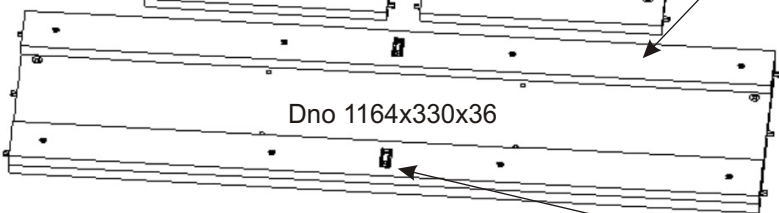
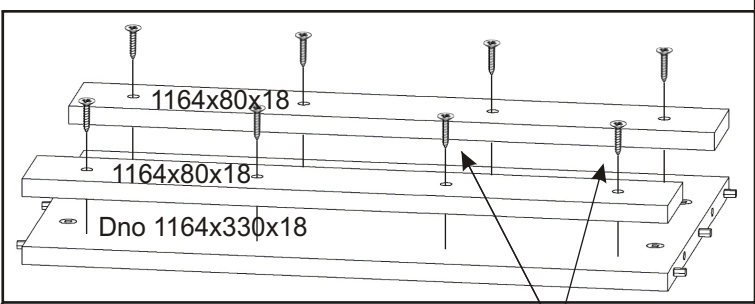
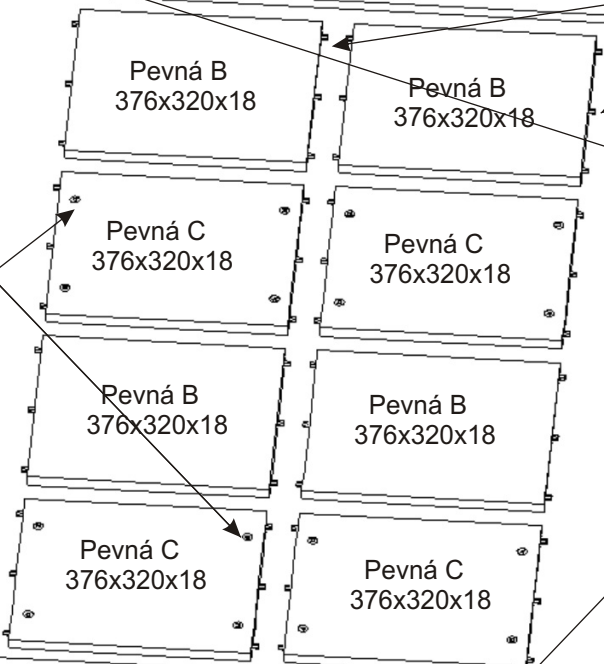
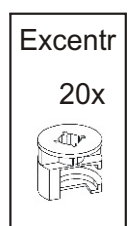
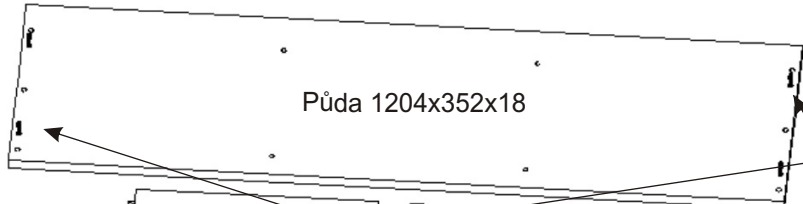
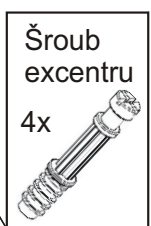
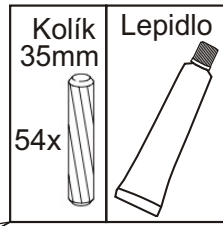

4.

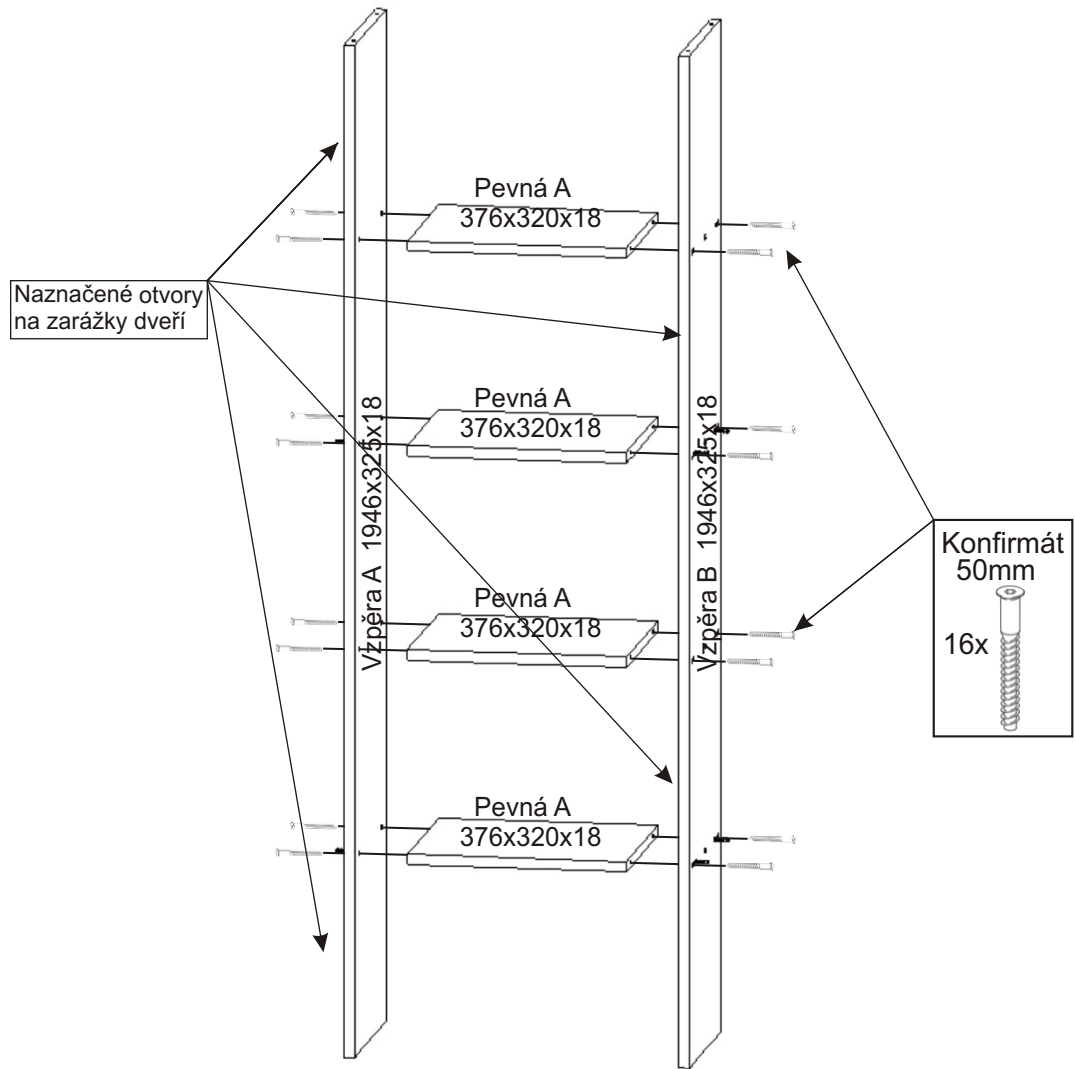

5.

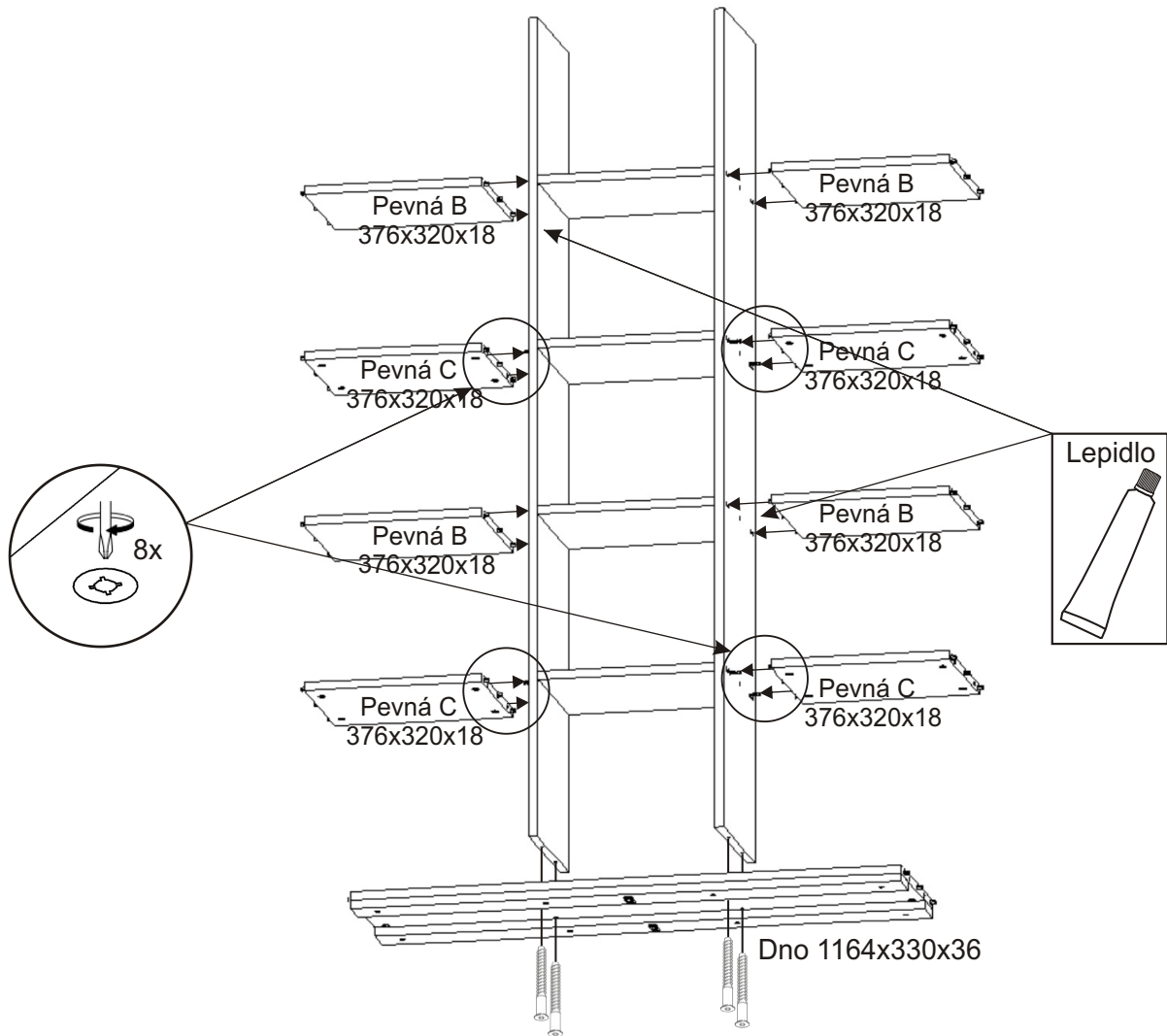

6.

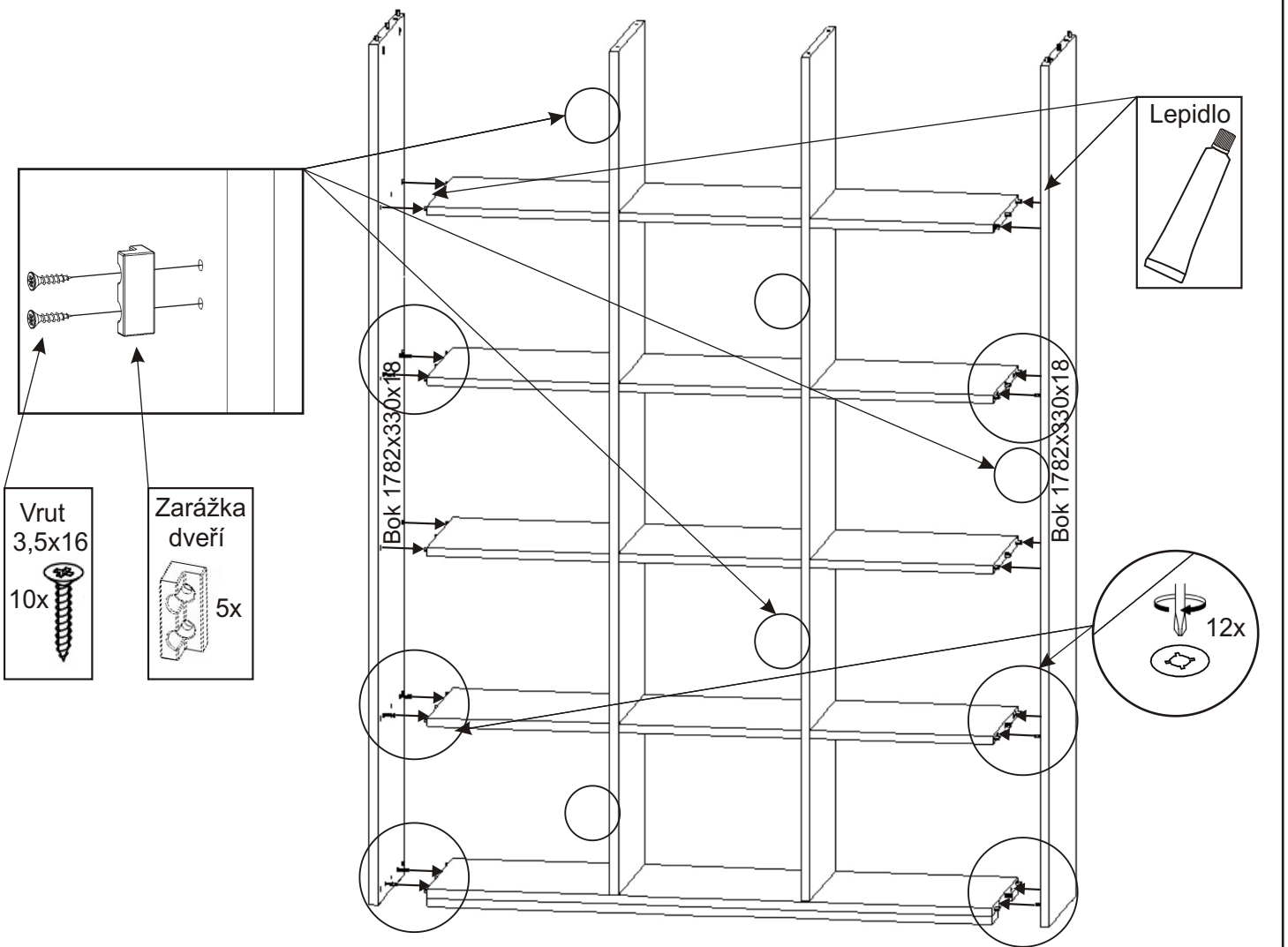

7.

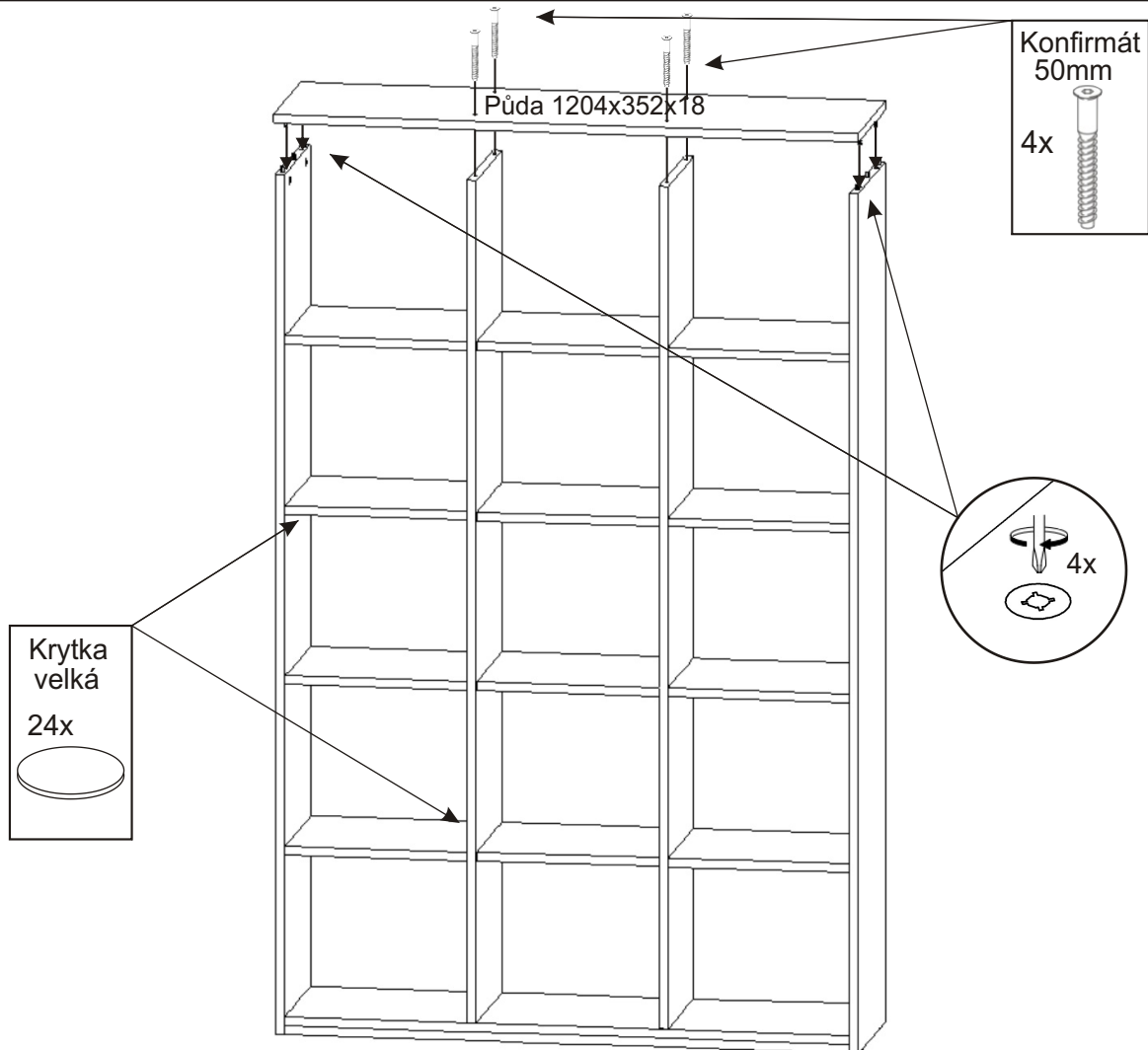

8.

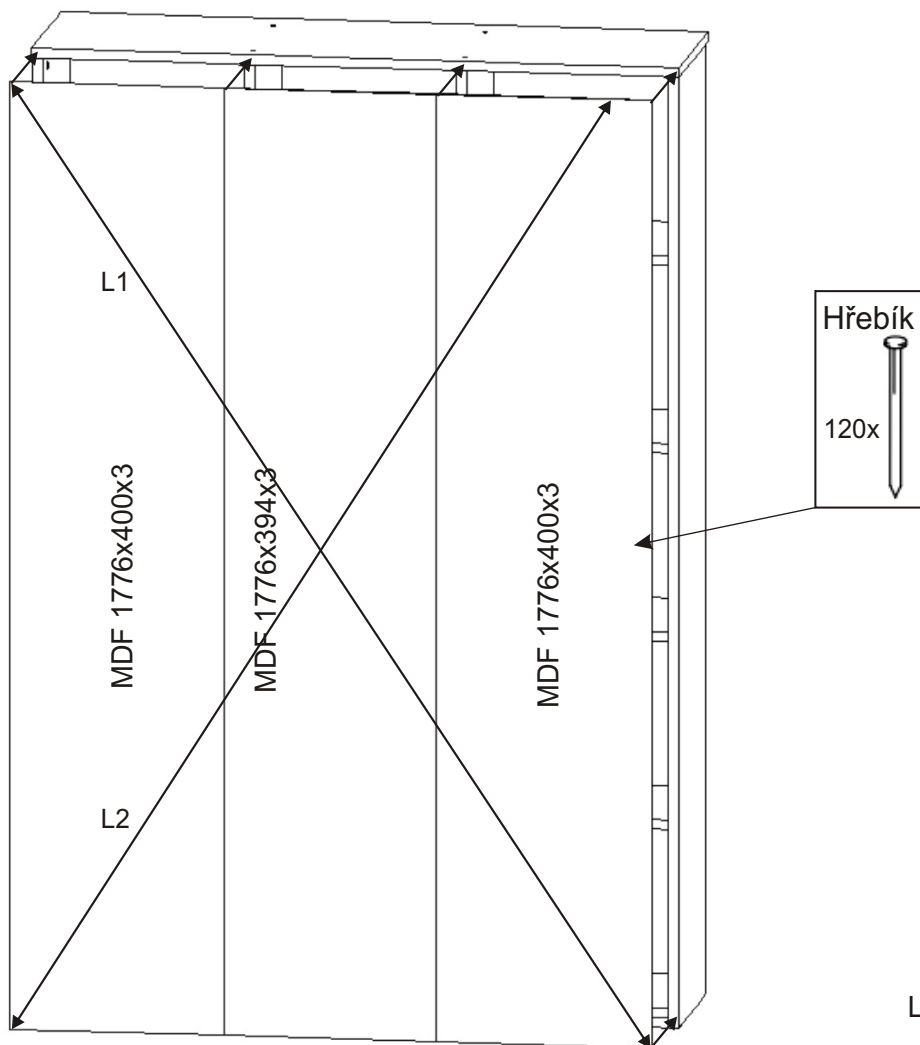

9.

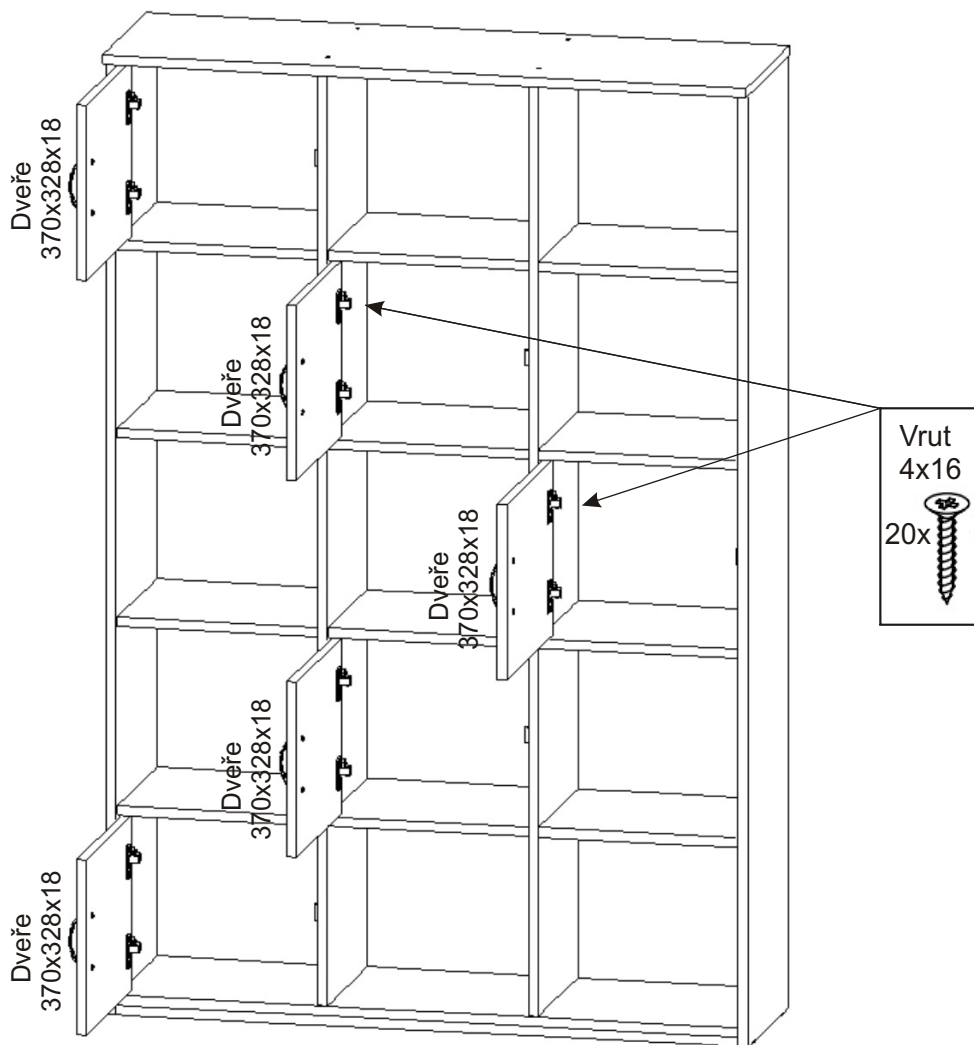

Skříň doporučujeme kvůli nebezpečí převržení připevnit ke zdi pomocí úhelníků. Skříň přisuneme ke zdi na místo kde bude umístěna a naznačíme otvory pro hmoždinky. Navrtáme otvory pro hmoždinky a připevníme dodanými vruty. (Námi dodávané hmoždinky jsou vhodné pro stěny z plyných materiálů.)

