

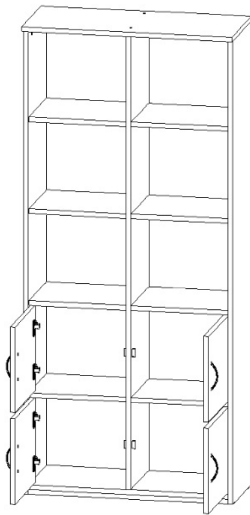

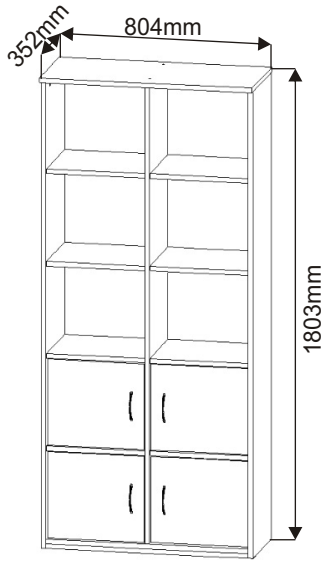

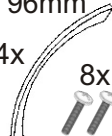





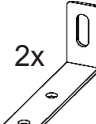
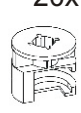

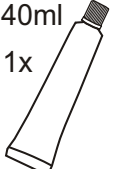



# ALFA 182



<b>Úchytka 96mm</b> 4x  8x  4x22mm	<b>Vložený pant s tlumením</b> 8x 	<b>Úhelník 73x31x15</b> 2x 	<b>Excentr 20x</b> 20x 	<b>Šroub excentru 20x</b> 20x 		
<b>Kolík 35mm</b> 42x 	<b>Lepidlo 40ml</b> 1x 	<b>Konfirmát 50mm</b> 12x 	<b>Hmoždinka ø10</b> 2x 	<b>Hřebík 92x</b> 92x 	<b>Krytka velká 18x</b> 18x 	
<b>Kluzáky</b> 6x 	<b>Zarážka dveří 4x</b> 4x 	<b>Vrut 3,5x16</b> 8x 	<b>Vrut 4x16</b> 32x 	<b>Vrut 4x20</b> 4x 	<b>Vrut 4x30</b> 6x 	<b>Vrut 5x50</b> 2x 

1.

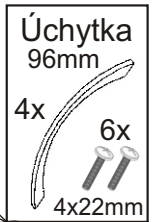
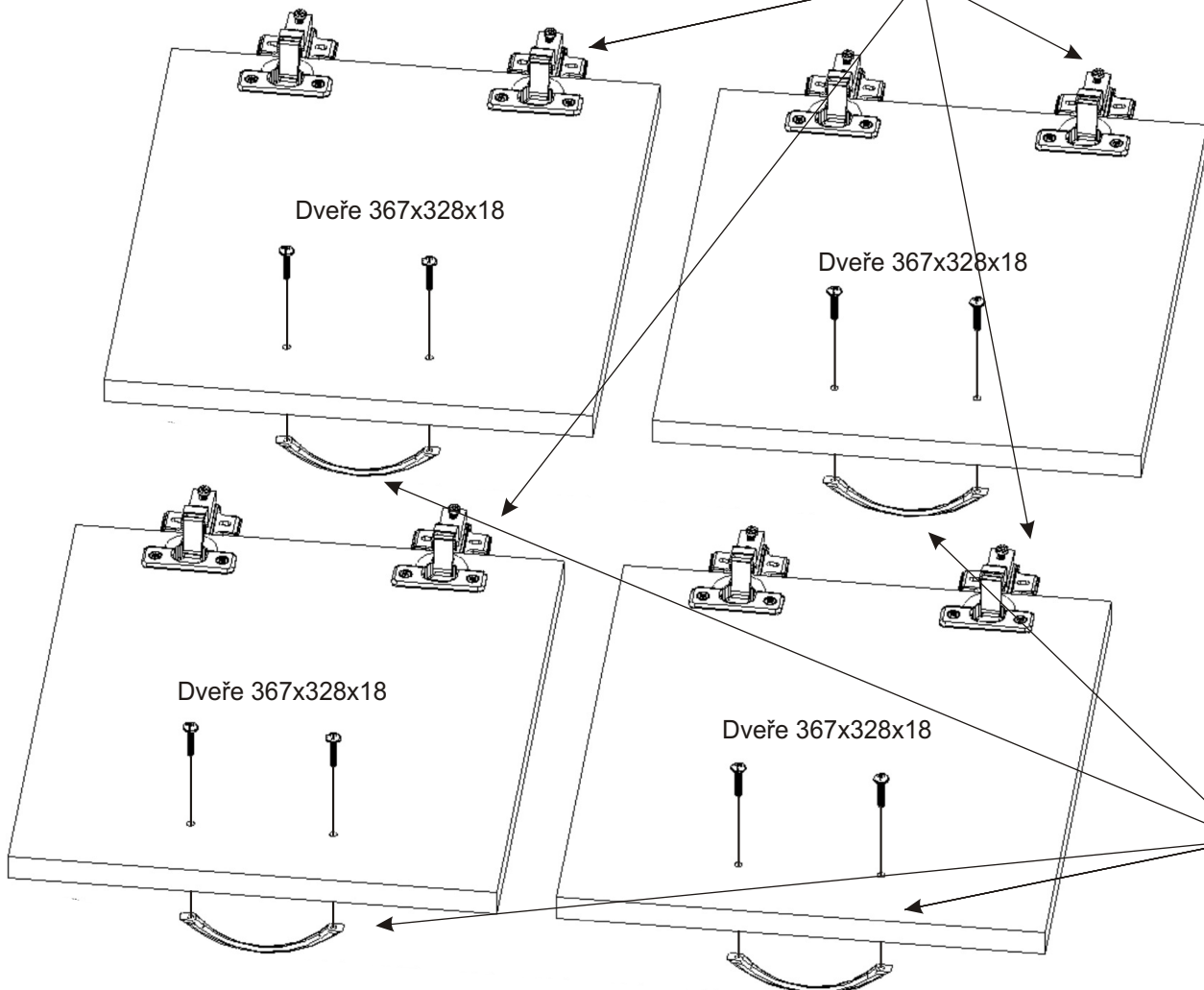
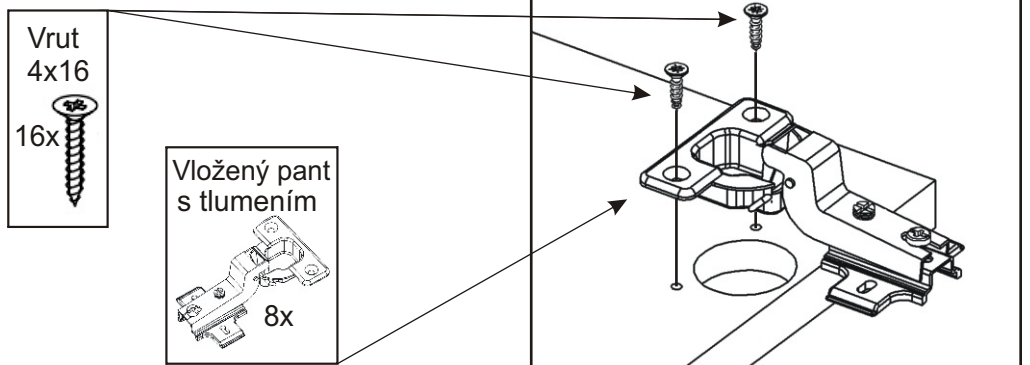

2.

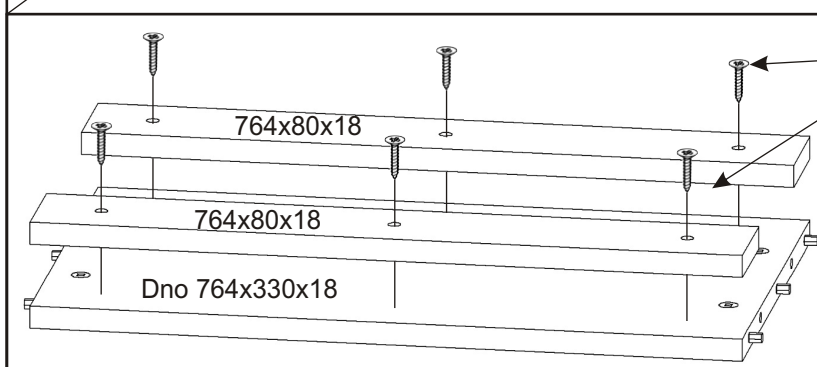
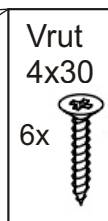
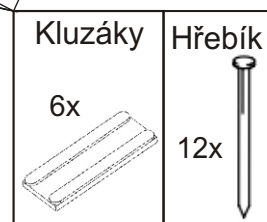
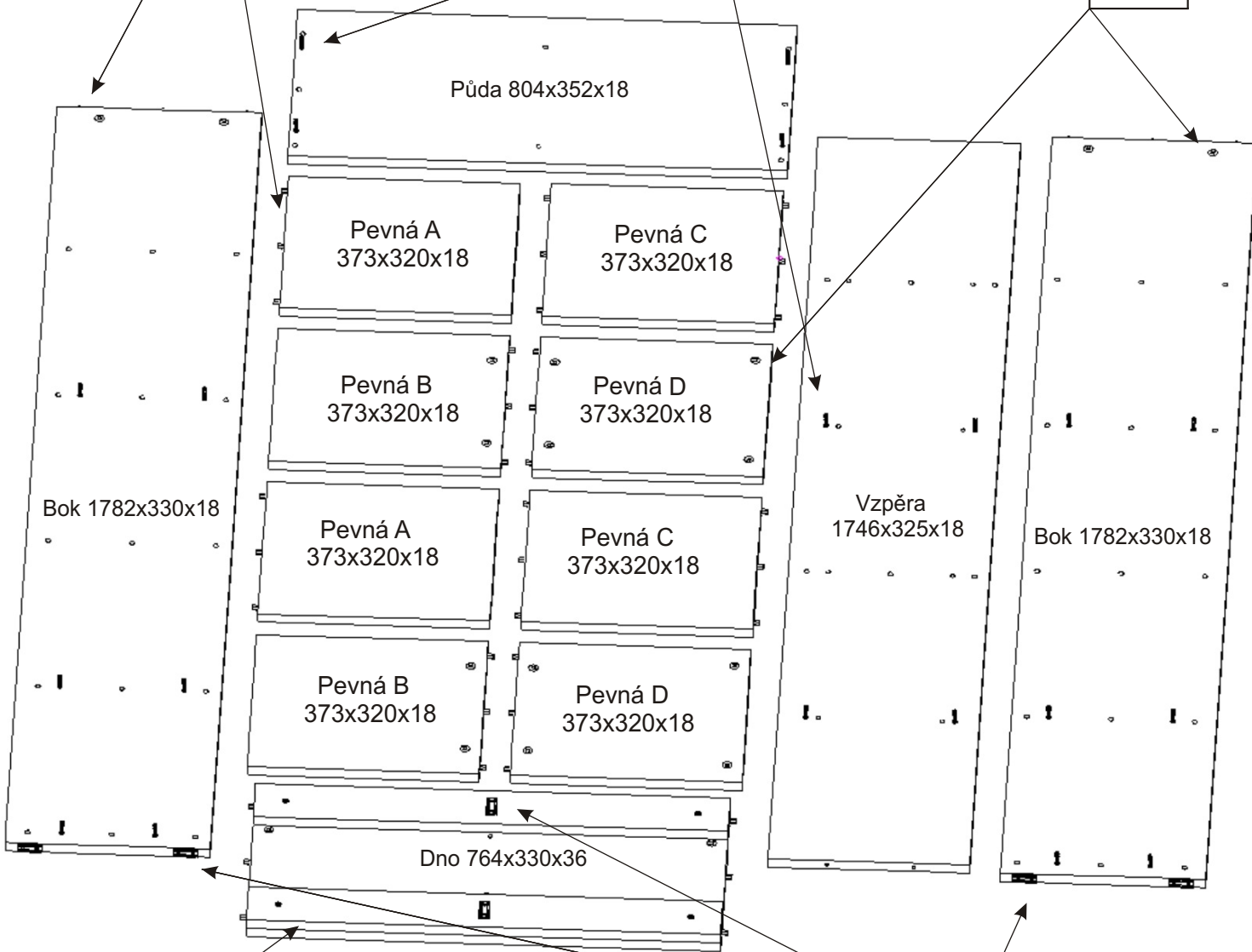
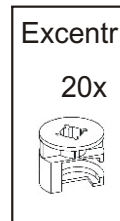
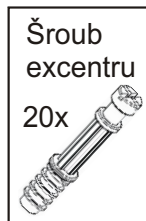
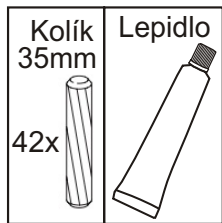

3.

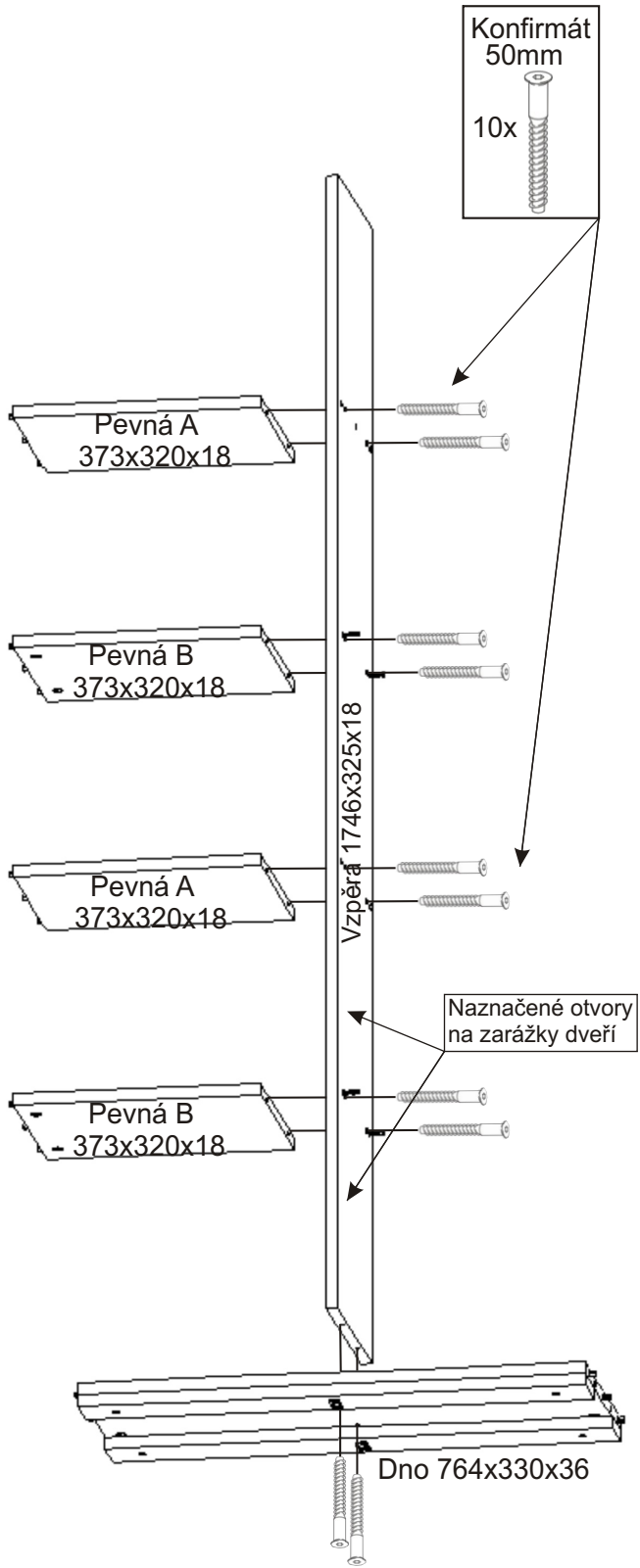

4.

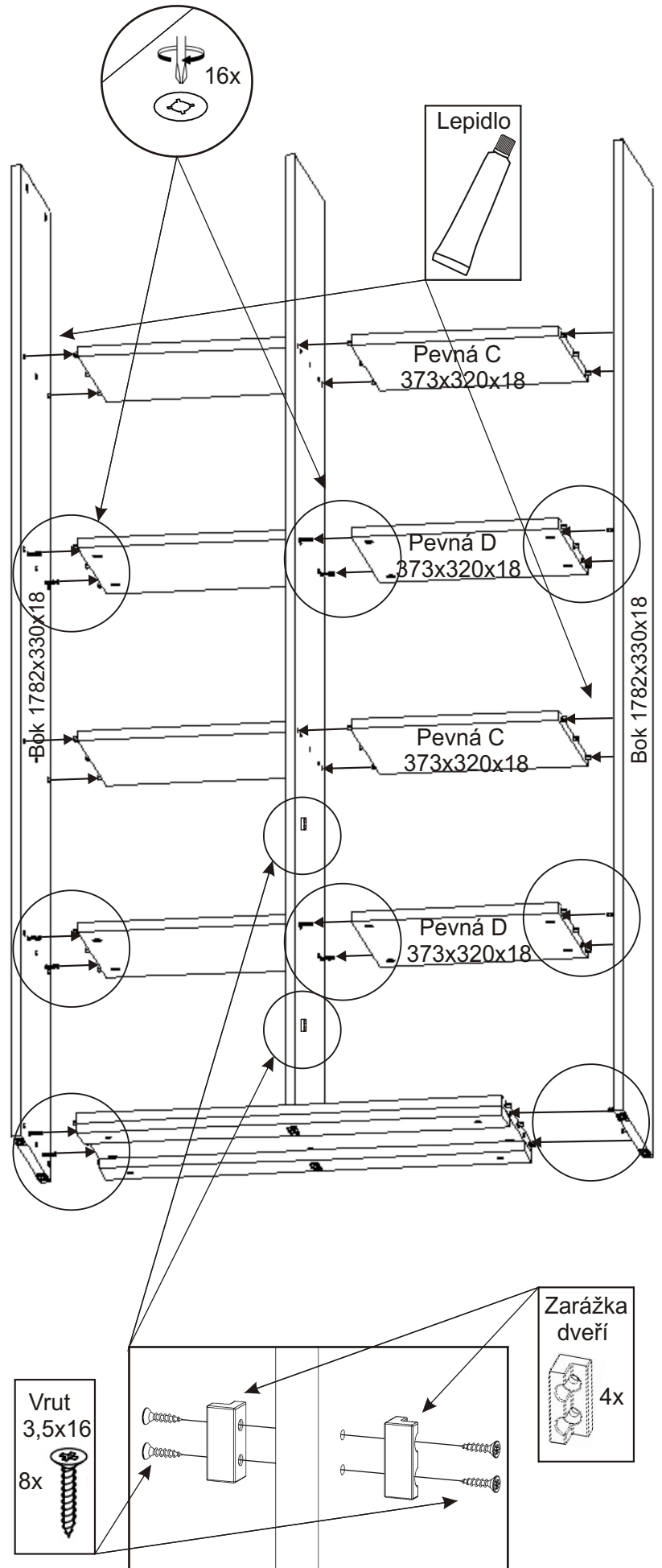

5.

Konfirmát  
50mm

2x

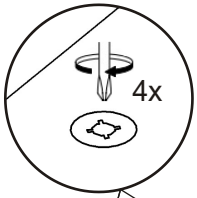

4x

Půda 804x352x18

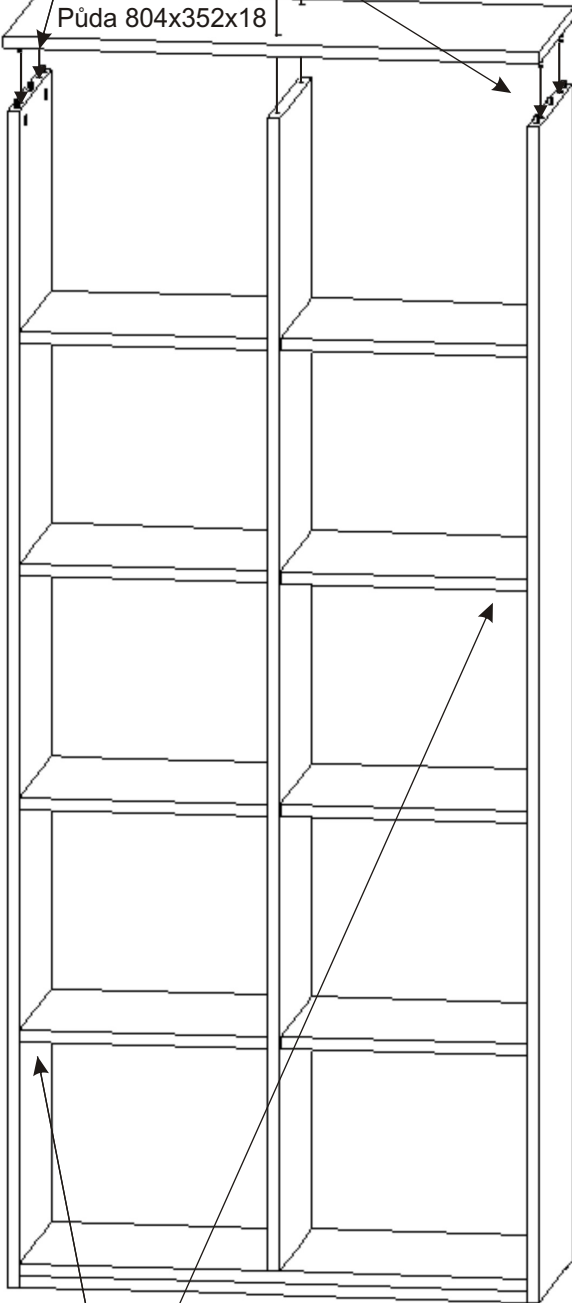

Krytka  
velká  
18x



6.

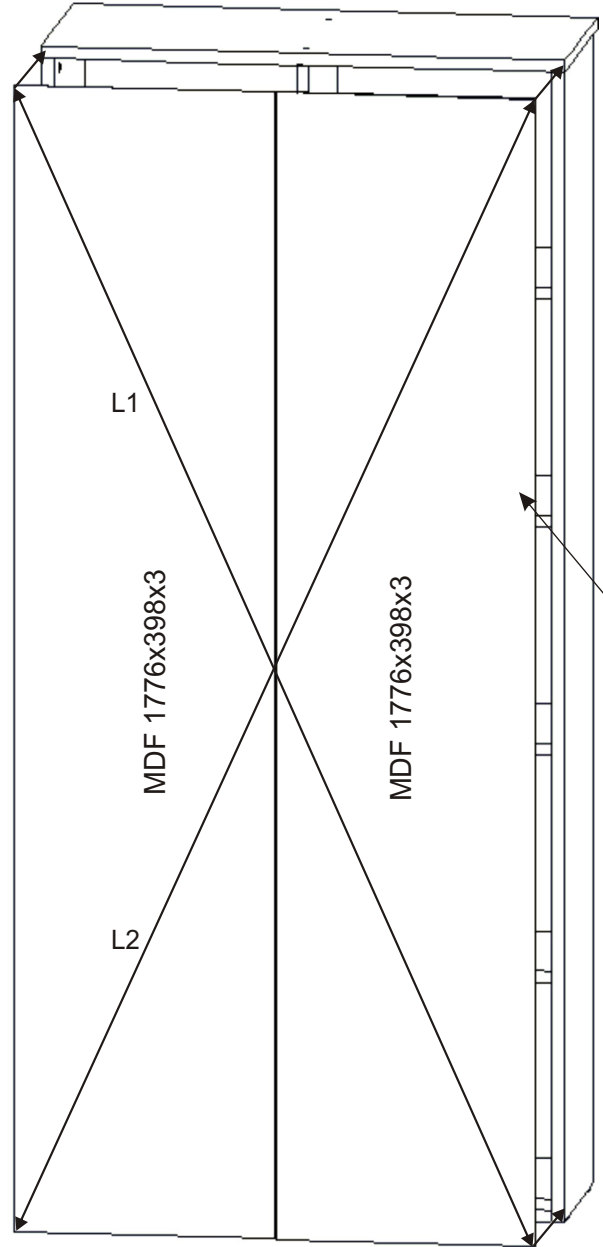

Hřebík

80x



L1 = L2

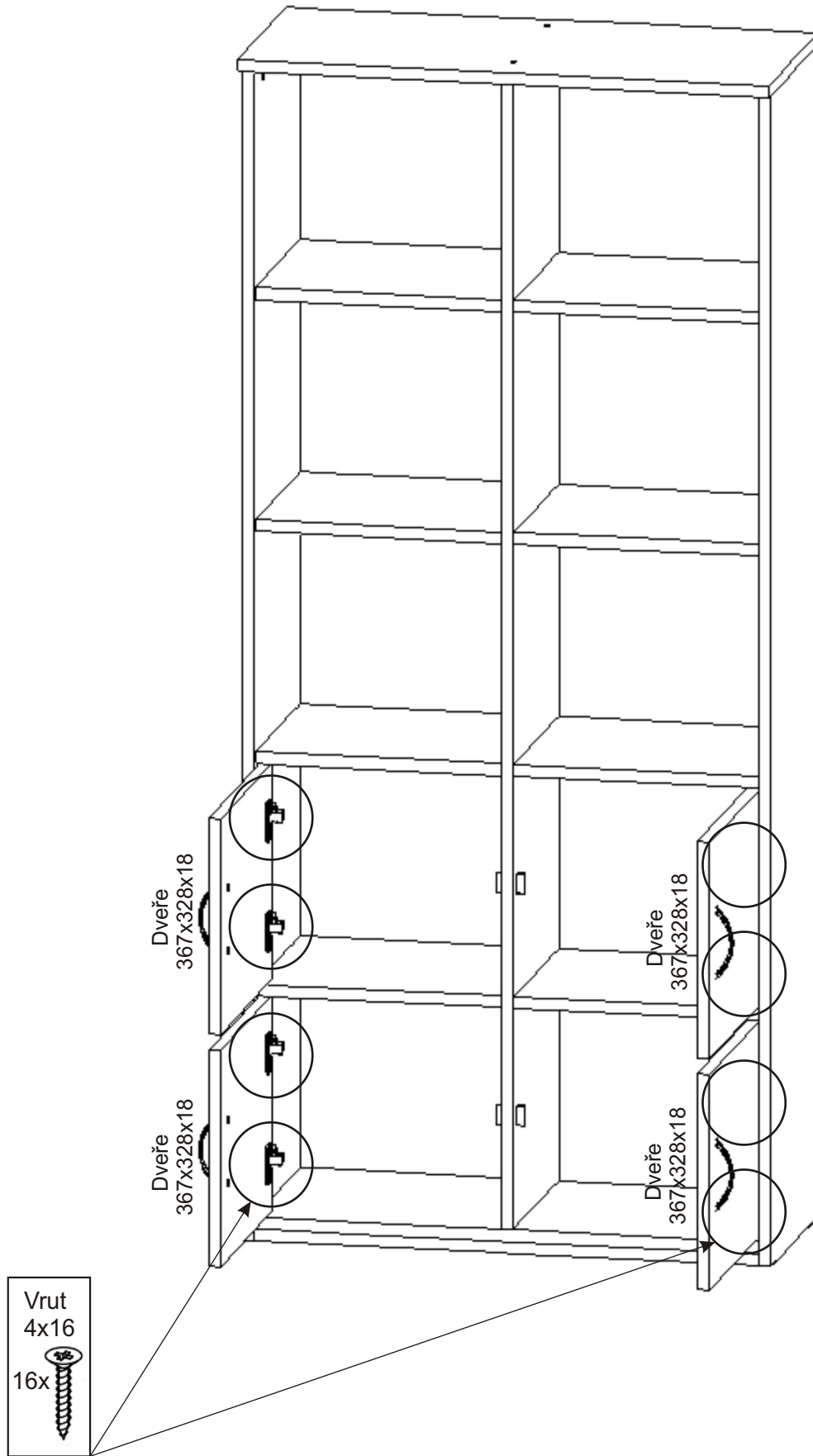

8.

Skříň doporučujeme kvůli nebezpečí převržení připevnit ke zdi pomocí úhelníků. Skříň přisuneme ke zdi na místo kde bude umístěna a naznačíme otvory pro hmoždinky. Navrtáme otvory pro hmoždinky a připevníme dodanými vruty. (Námi dodávané hmoždinky jsou vhodné pro stěny z plných materiálů.)

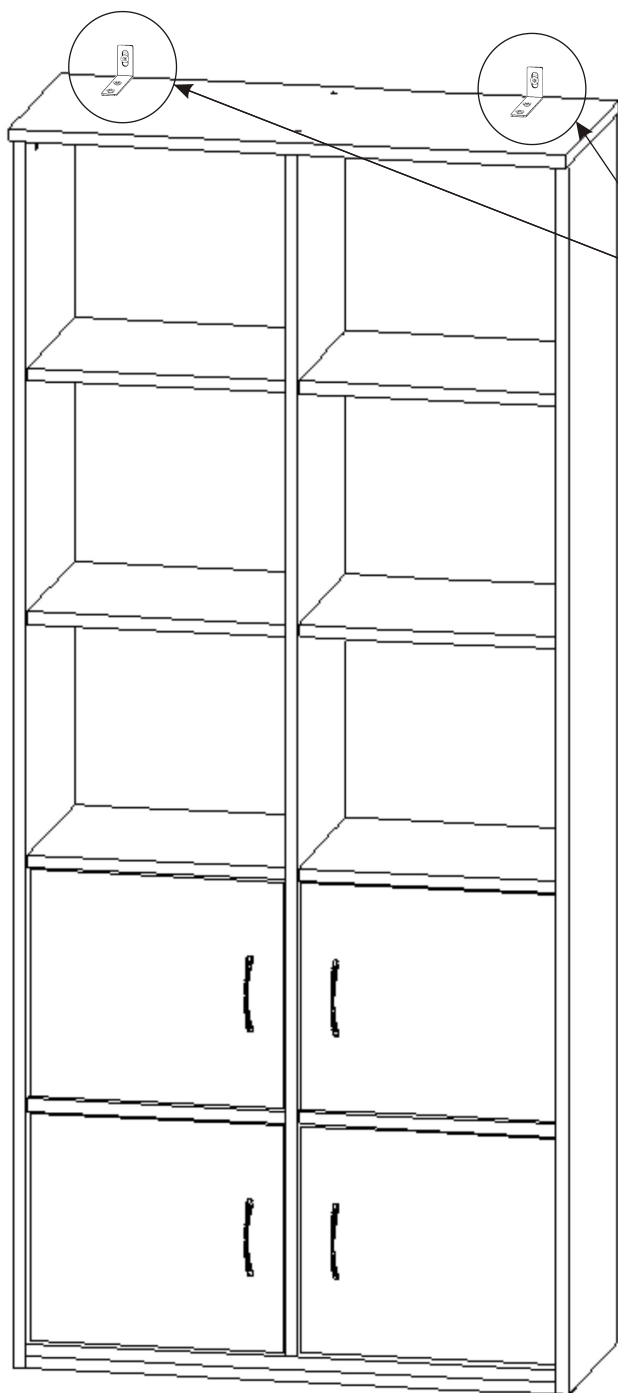

8.1.

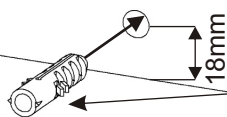

Hmoždinka

Ø10

2x



8.2.

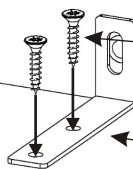

Vrut  
4x20

4x



8.3.

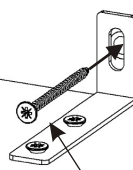

Úhelník  
73x31x15

2x

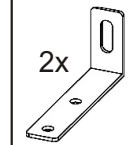

Vrut  
5x50

2x

