

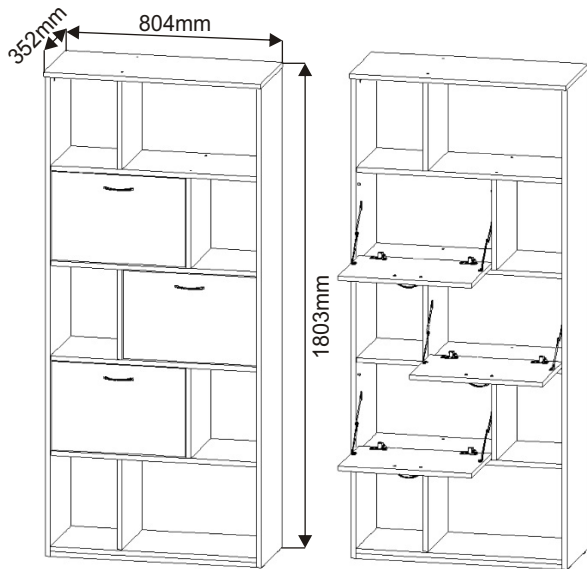

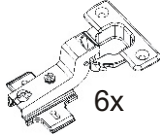

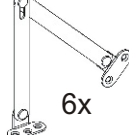

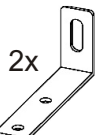

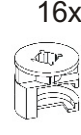

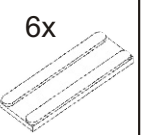
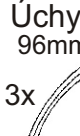
ALFA 180

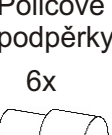
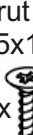
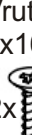
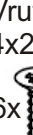
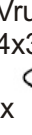

Vložený pant s tlumením  6x	Závěs dveří  6x	Úhelník 73x31x15  2x	Excentr 16x  16x	Šroub excentru 16x  16x	Kluzáky 6x  6x	
Úchytka 96mm 3x  6x 4x22mm	Kolík 35mm 36x  36x	Lepidlo 40ml 1x  1x	Konfirmát 50mm 20x  20x	Hmoždinka ø10 2x  2x	Hřebík 72x  72x	Krytka velká 30x  30x
Policové podpěrky 6x  6x	Vrut 3,5x16 24x  24x	Vrut 4x16 12x  12x	Vrut 4x20 16x  16x	Vrut 4x30 6x  6x	Vrut 5x50 2x  2x	H lišta 1745mm 1x  1x

1.

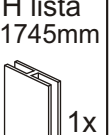
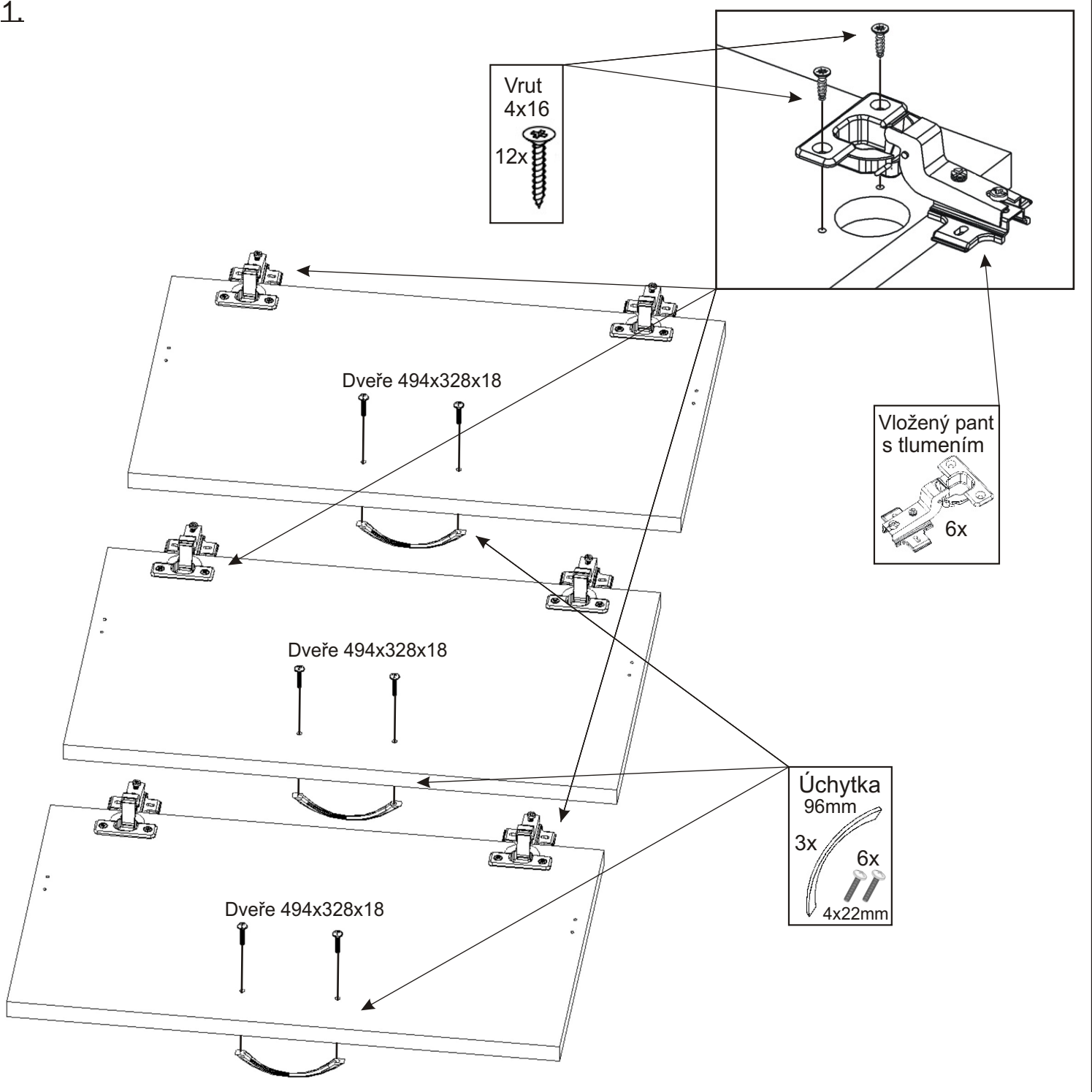

2.

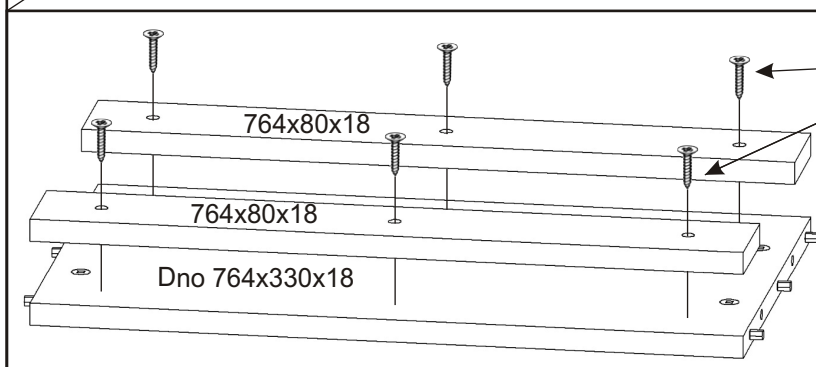
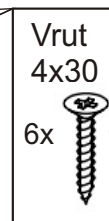
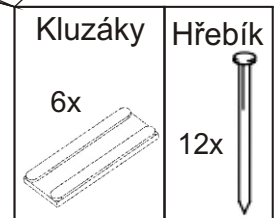
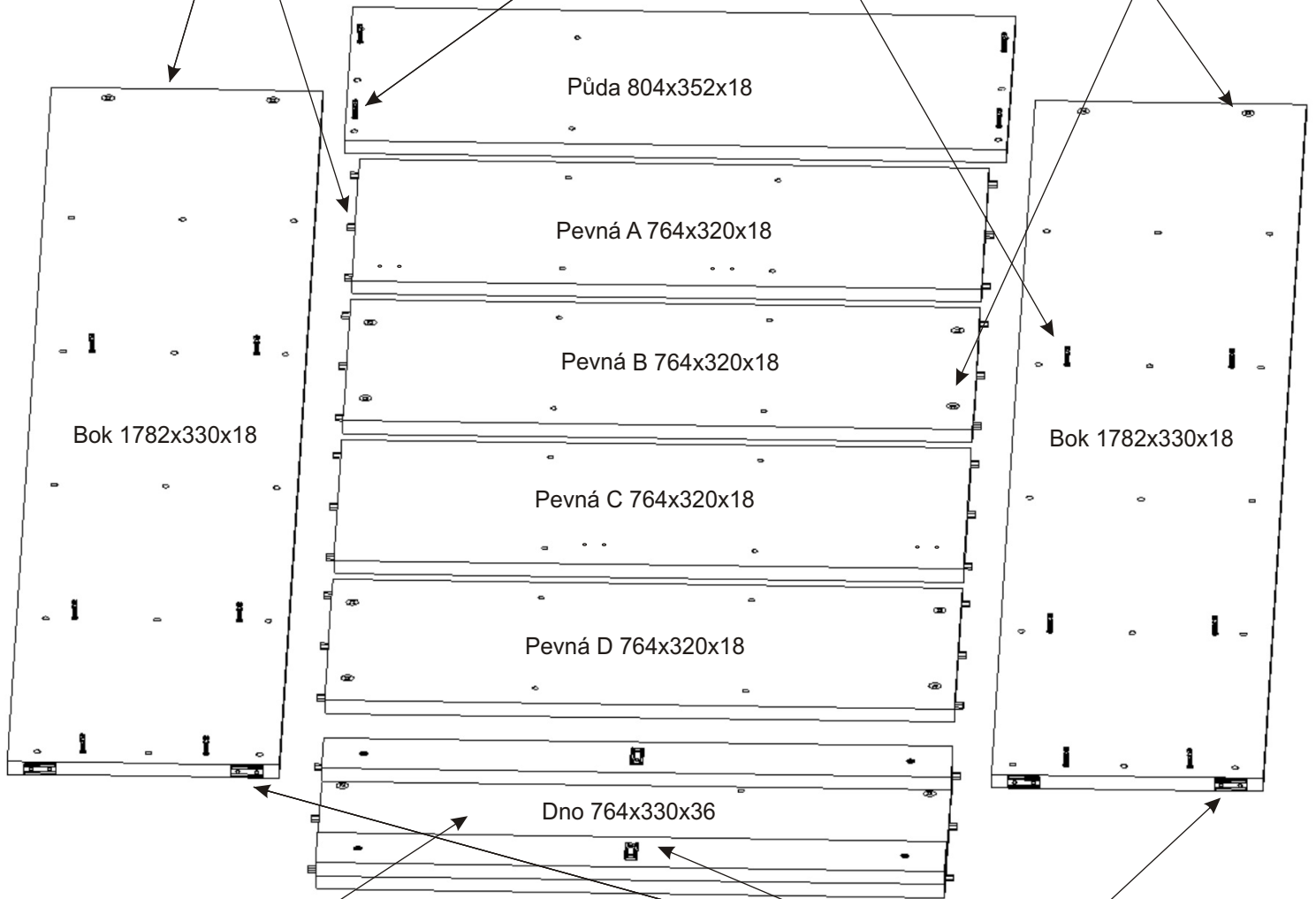
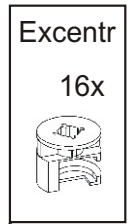
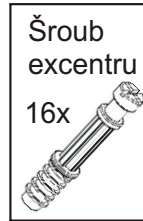
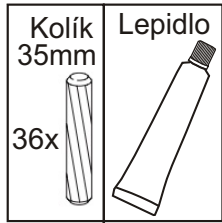

3.

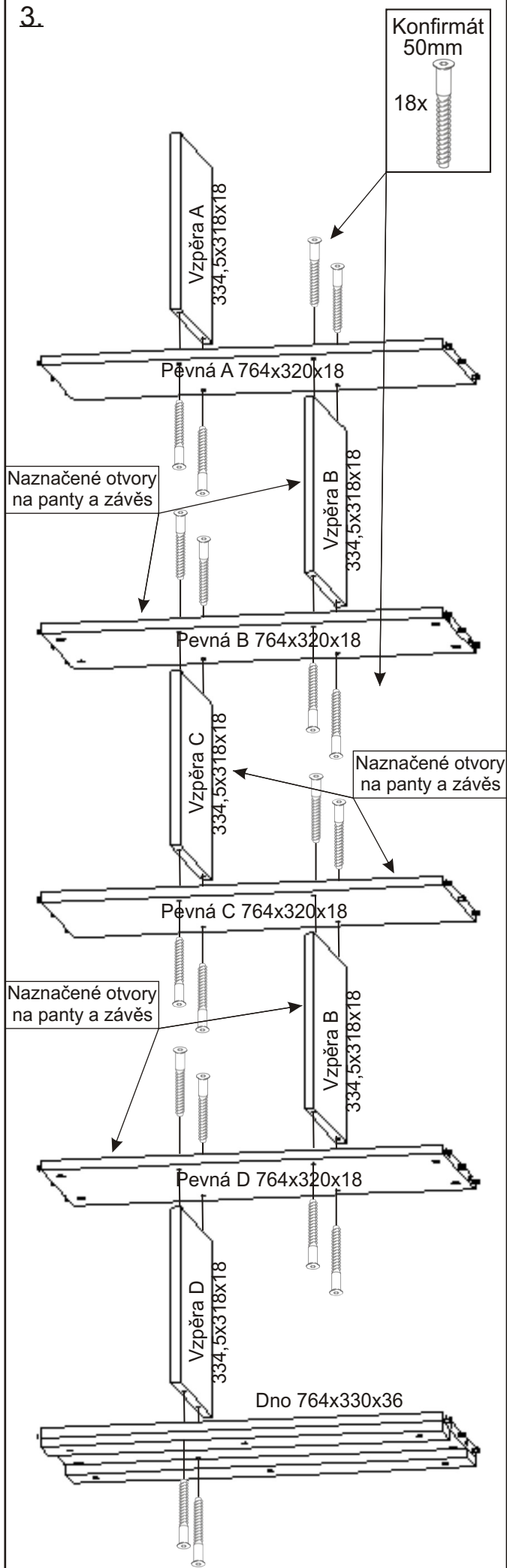

4.

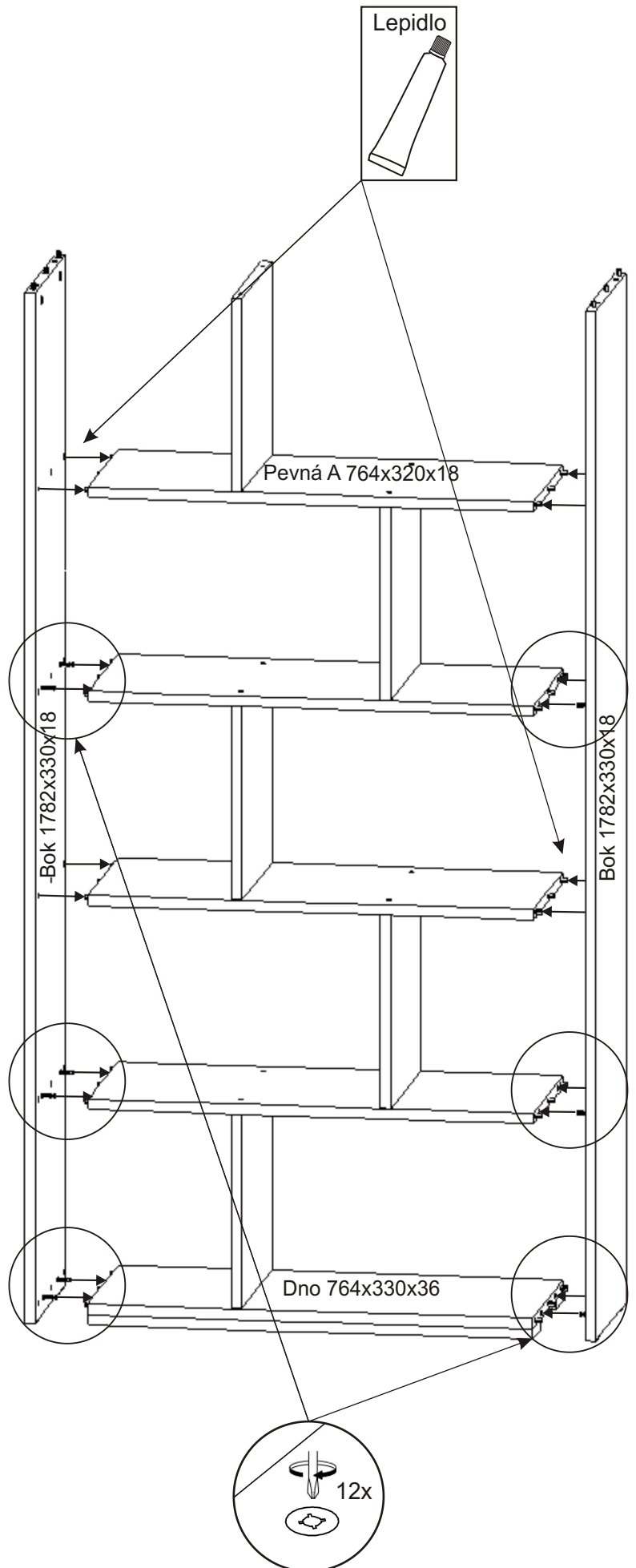

5.

Konfirmát
50mm

2x

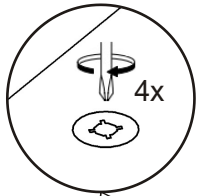

4x

Půda 804x352x18

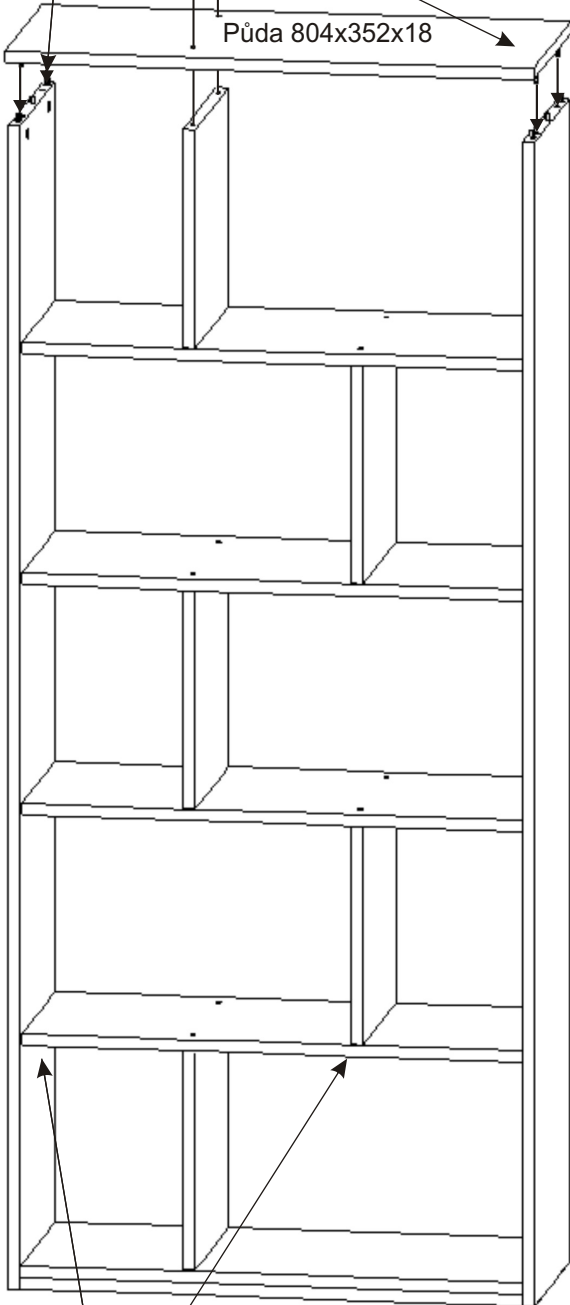

Krytka
velká

30x

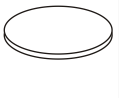

6.

L1

H lišta
1745mm

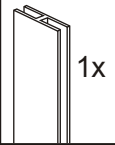

1x

MDF 1776x398x3

MDF 1776x398x3

L2

Hřebík

60x



L1 = L2

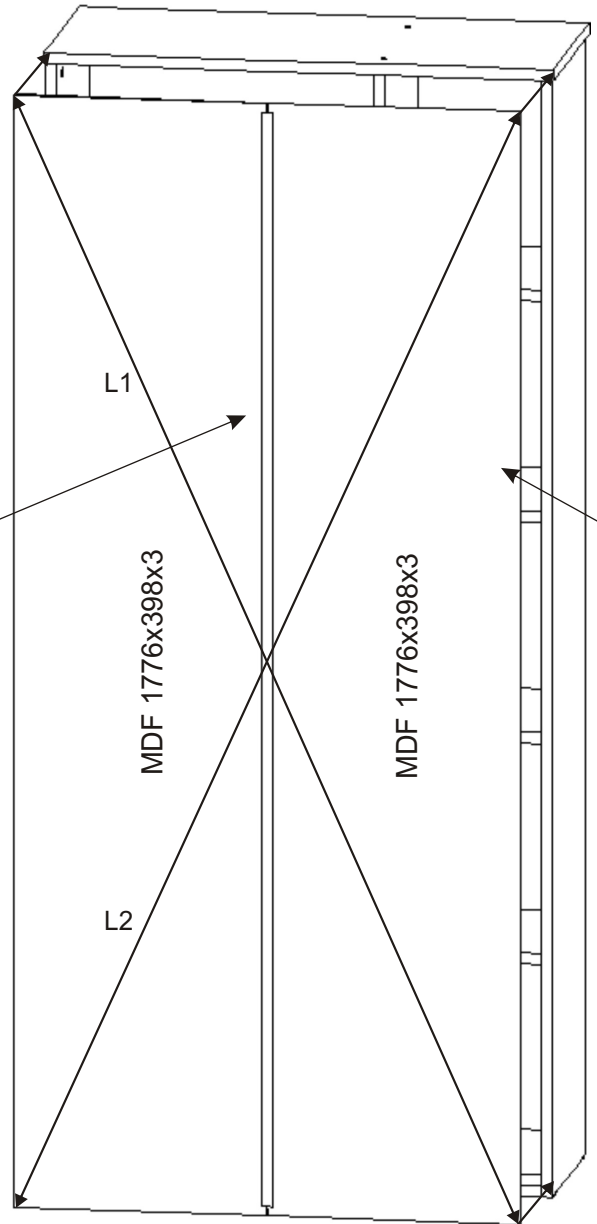

7.

Závěs dveří

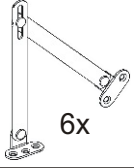

6x

Policové podpěrky

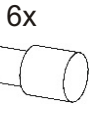

6x

7.1.

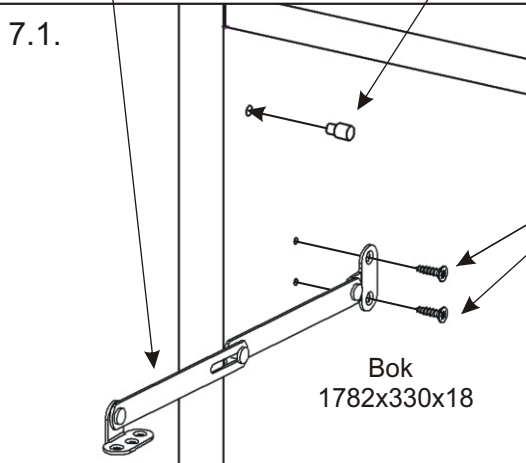

Bok
1782x330x18

Vrut
3,5x16



12x

7.2.

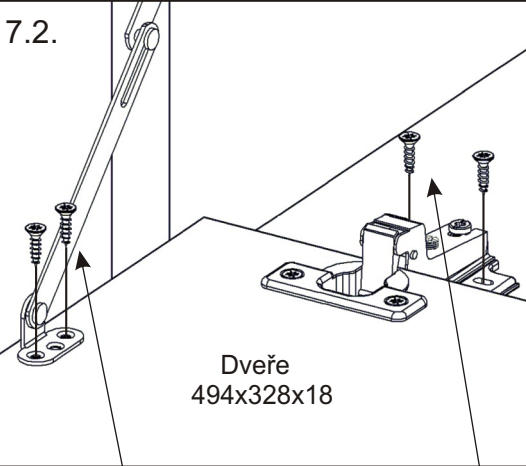

Dveře
494x328x18

Vrut
3,5x16

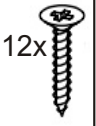

12x

Vrut
4x20

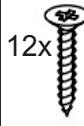

12x

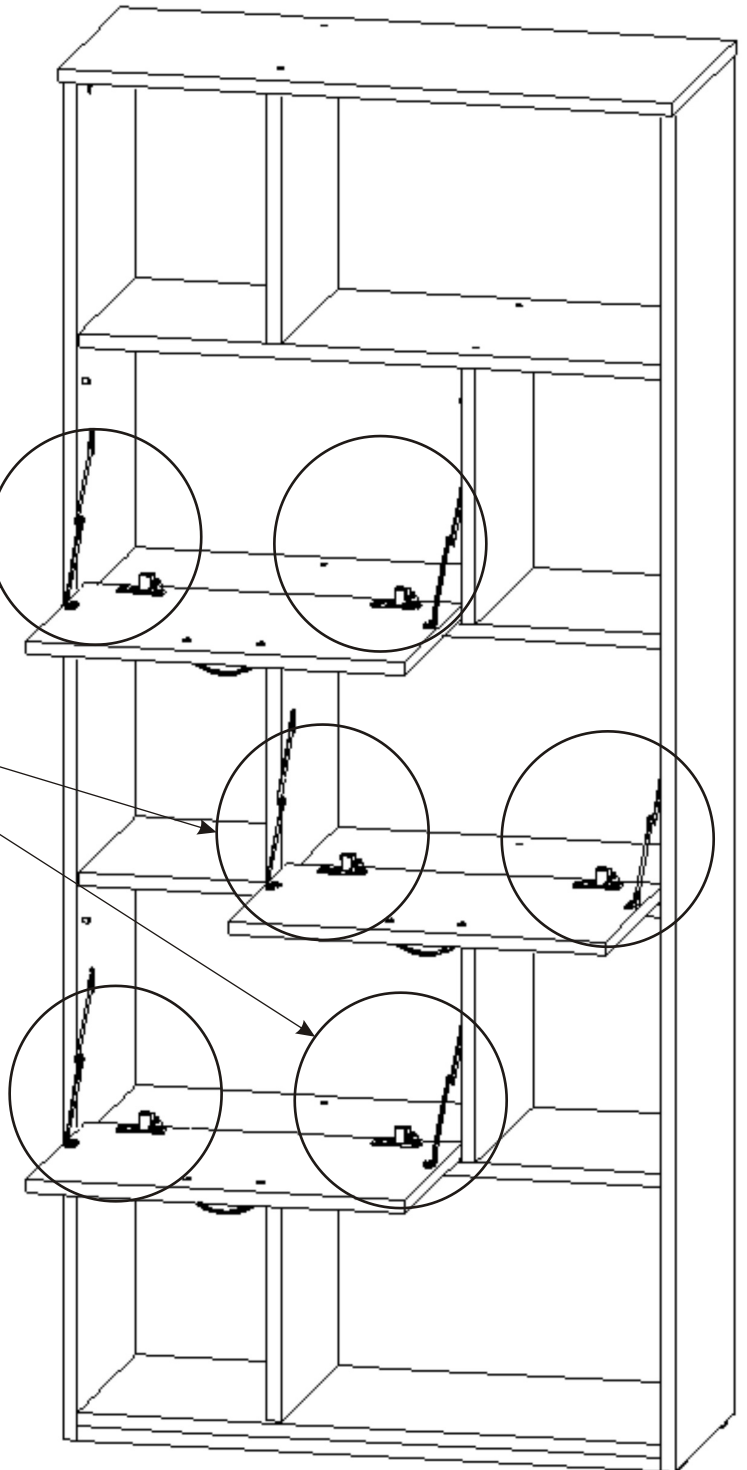

8.

Skříň doporučujeme kvůli nebezpečí převržení připevnit ke zdi pomocí úhelníků. Skříň přisuneme ke zdi na místo kde bude umístěna a naznačíme otvory pro hmoždinky. Navrtáme otvory pro hmoždinky a připevníme dodanými vruty. (Námi dodávané hmoždinky jsou vhodné pro stěny z plných materiálů.)

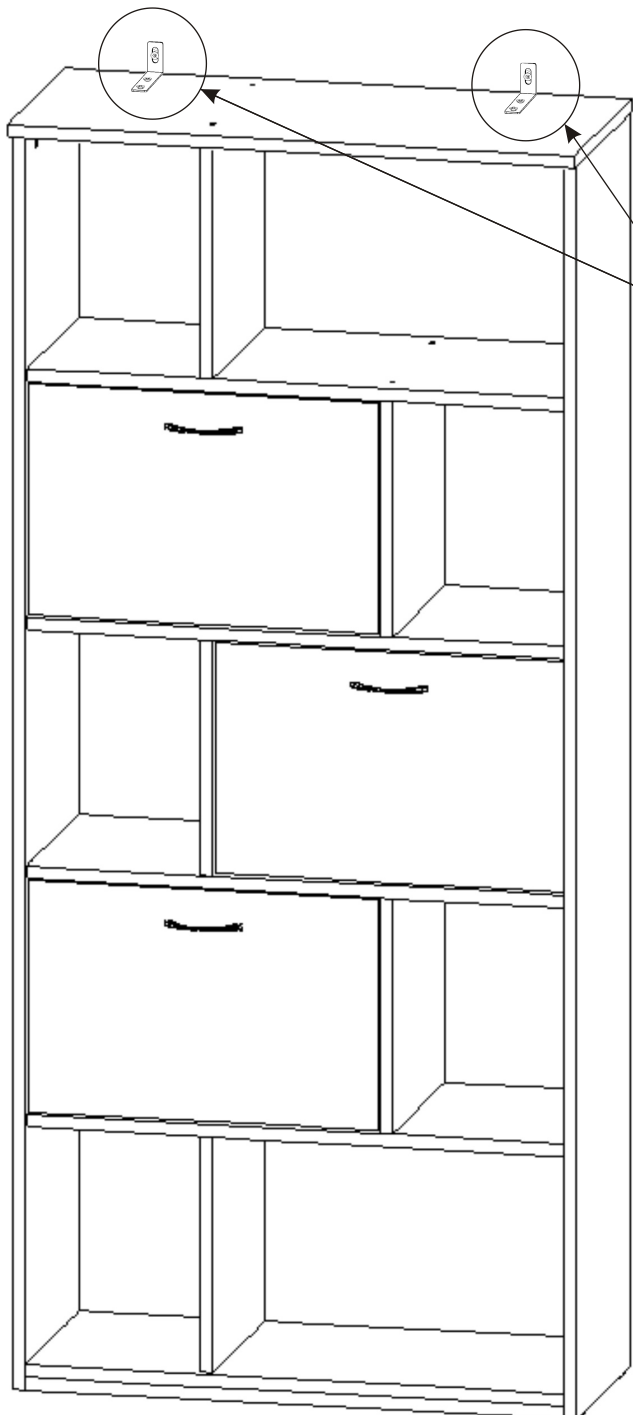

8.1.

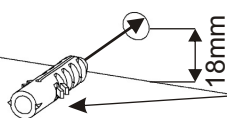

Hmoždinka

ø10

2x



8.2.

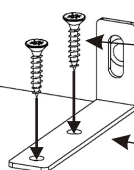

Vrut
4x20

4x



8.3.

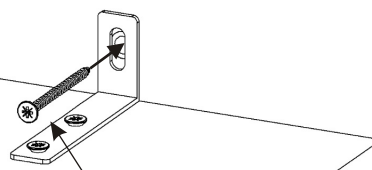

Úhelník
73x31x15

2x

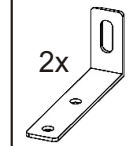

Vrut
5x50

2x

