

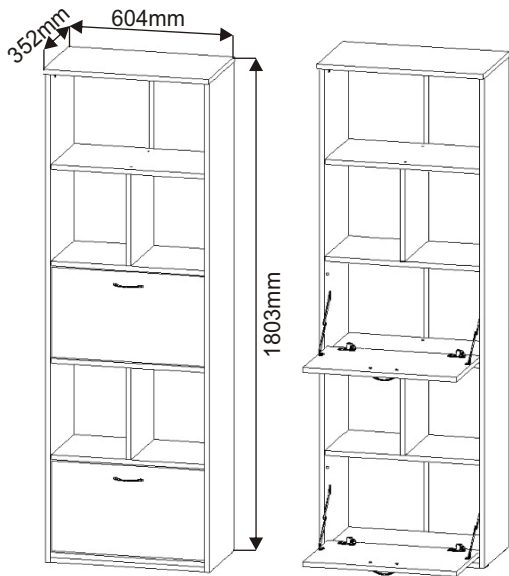

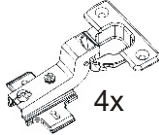

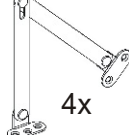

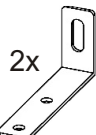

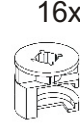





# ALFA 178

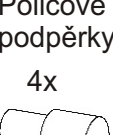
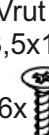

<b>Vložený pant s tlumením</b>  4x	<b>Závěs dveří</b>  4x	<b>Úhelník</b> 73x31x15  2x	<b>Excentr</b> 16x  16x	<b>Šroub excentru</b> 16x  16x	<b>Kluzáky</b> 4x  4x	
<b>Úchytka</b> 96mm  2x  4x 4x22mm	<b>Kolík</b> 35mm  36x	<b>Lepidlo</b> 40ml  1x	<b>Konfirmát</b> 50mm  8x	<b>Hmoždinka</b> ø10  2x	<b>Hřebík</b> 58x  58x	<b>Krytka velká</b> 20x  20x
<b>Policové podpěrky</b> 4x  4x	<b>Vrut</b> 3,5x16  16x	<b>Vrut</b> 4x16  8x	<b>Vrut</b> 4x20  12x	<b>Vrut</b> 4x30  6x	<b>Vrut</b> 5x50  2x	<b>H lišta</b> 334mm  3x

1.

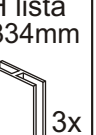
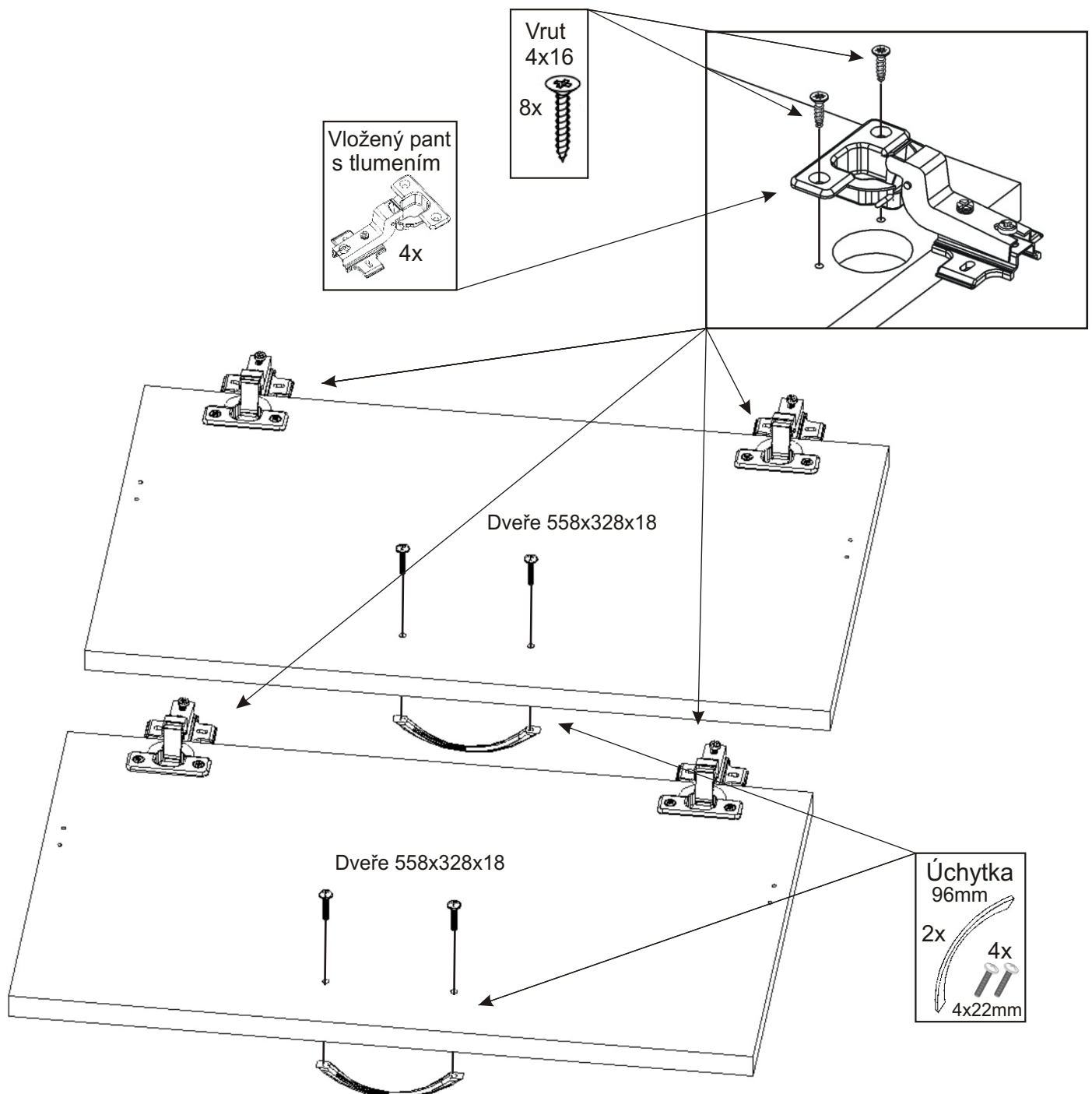

2.

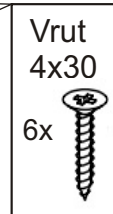
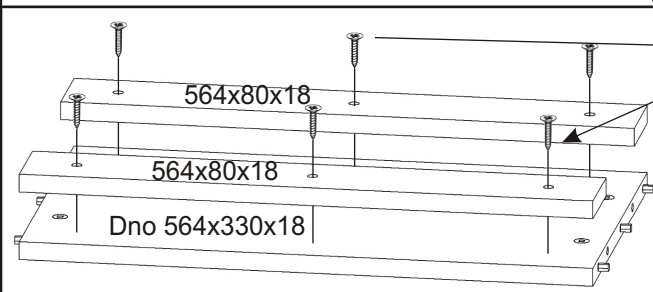
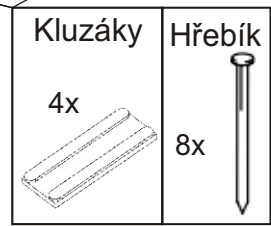
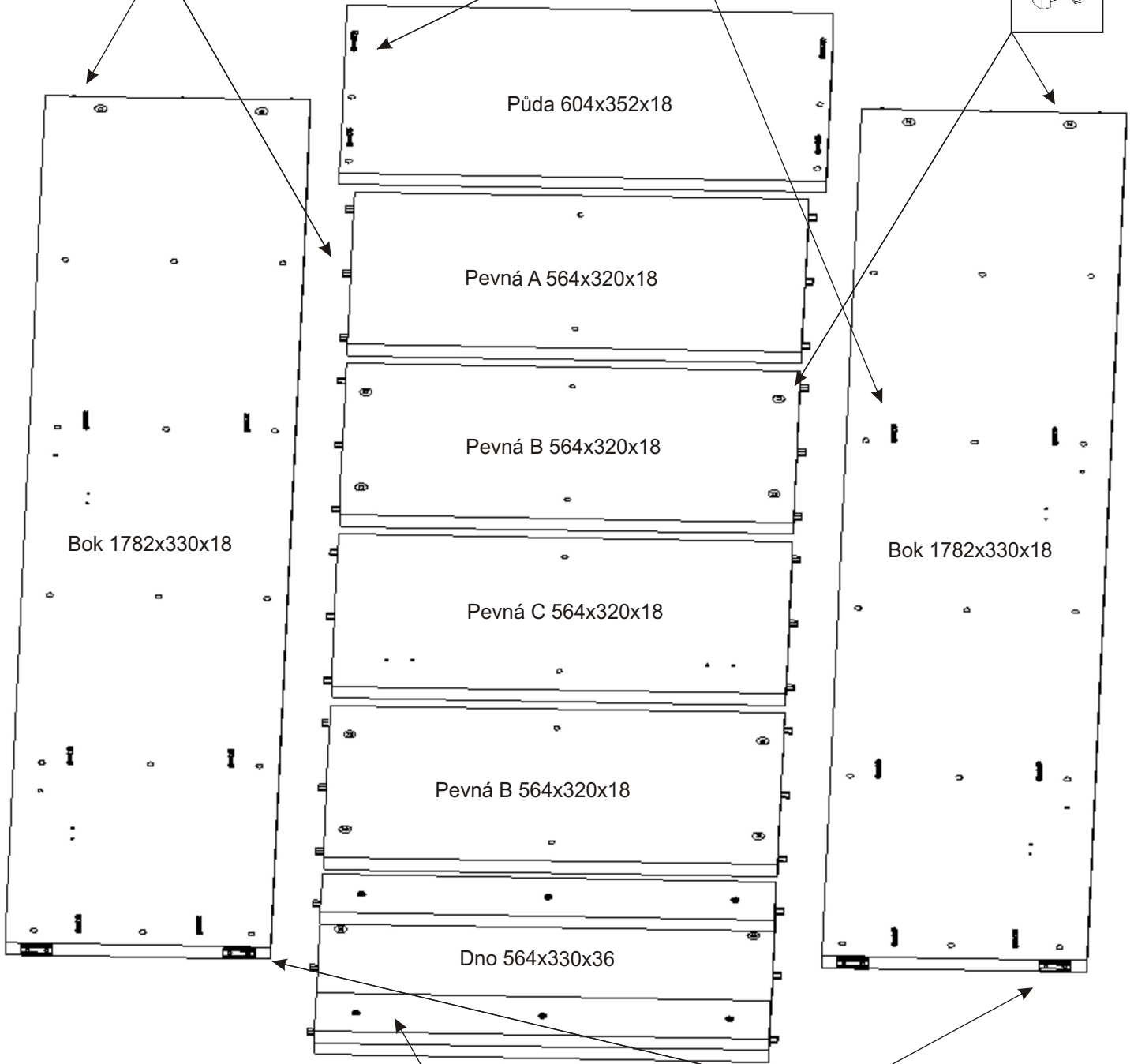
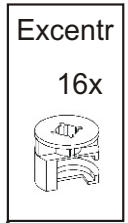
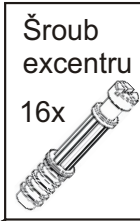
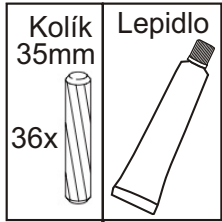

3.

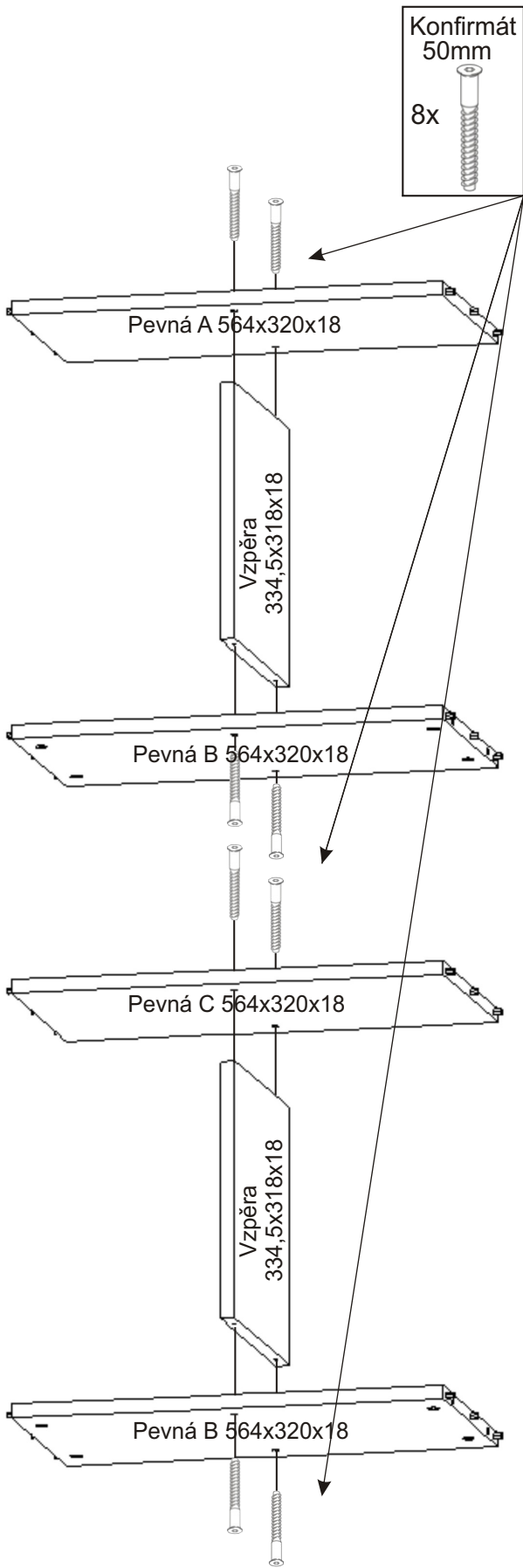

4.

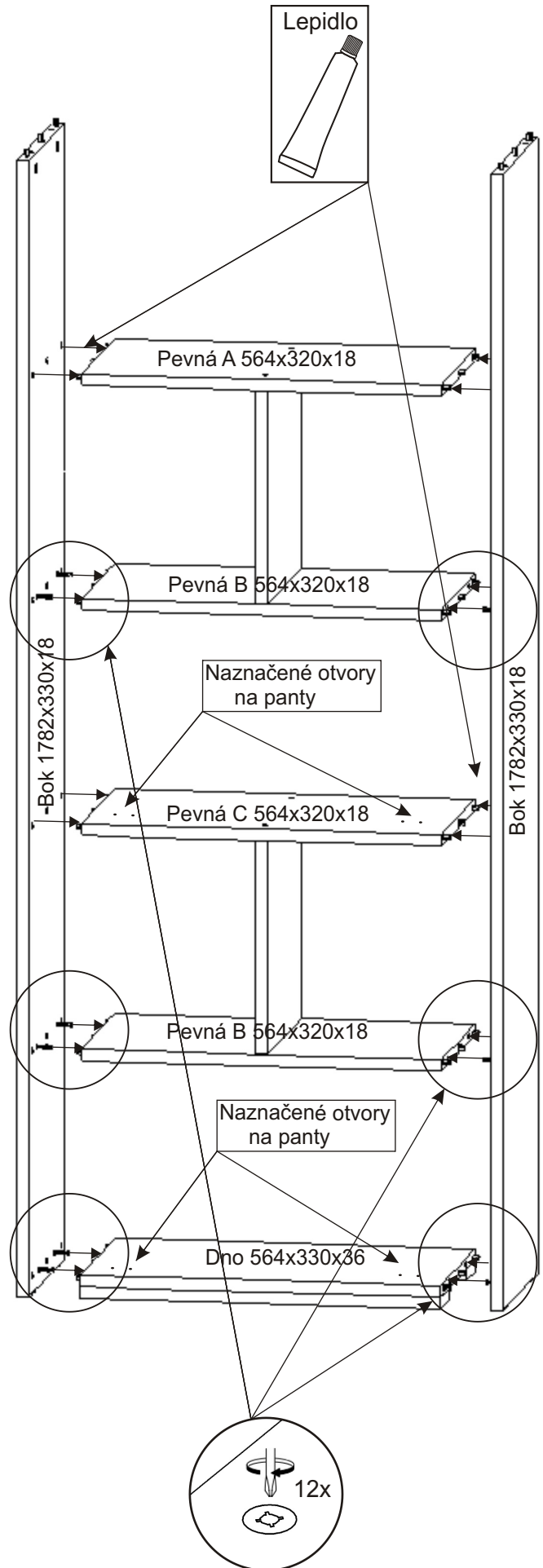

5.

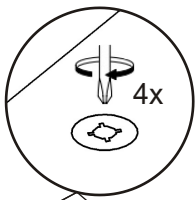

Půda 604x352x18

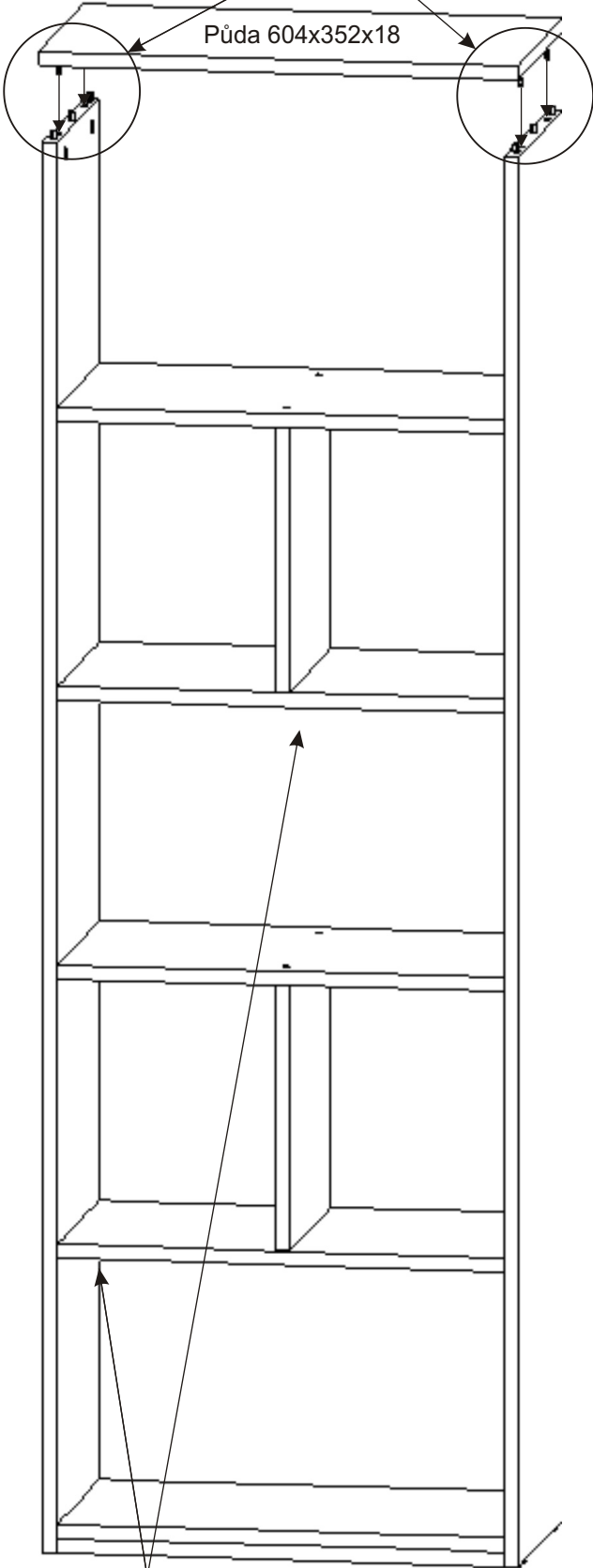

Krytka  
velká  
20x



6.

H lišta  
334mm

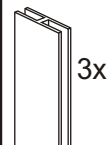

MDF 1776x298x3

MDF 1776x298x3

Hřebík

50x

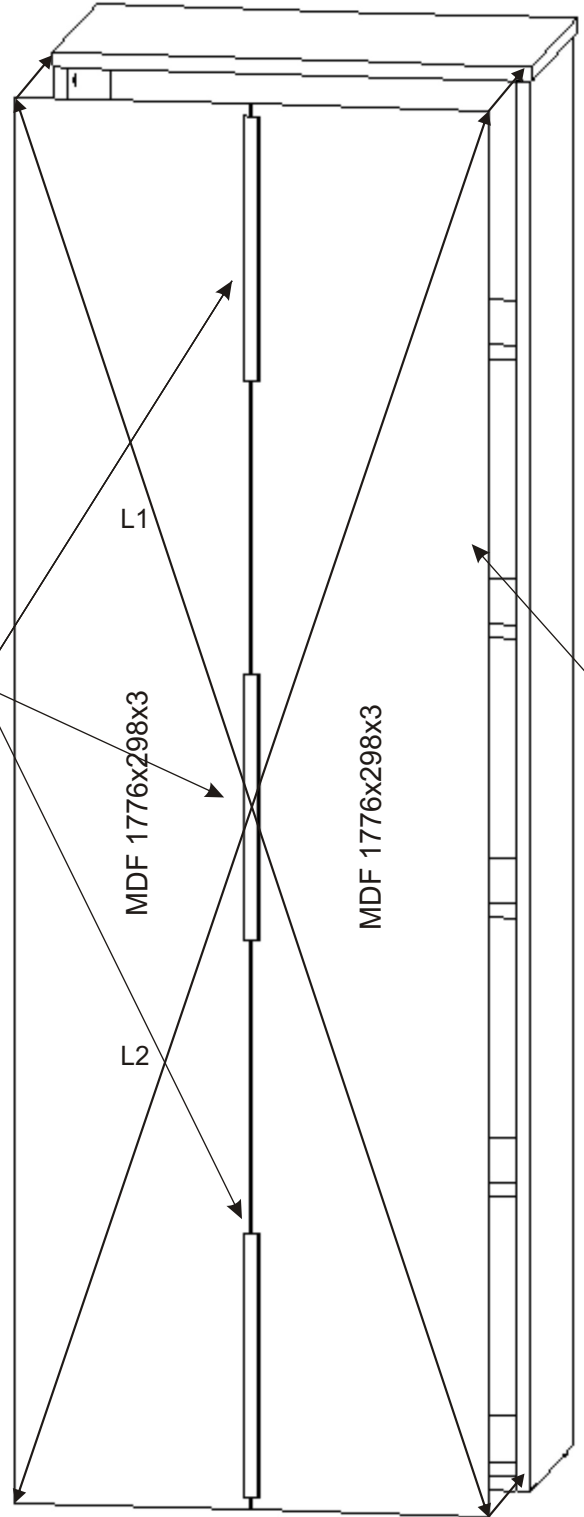

L1 = L2

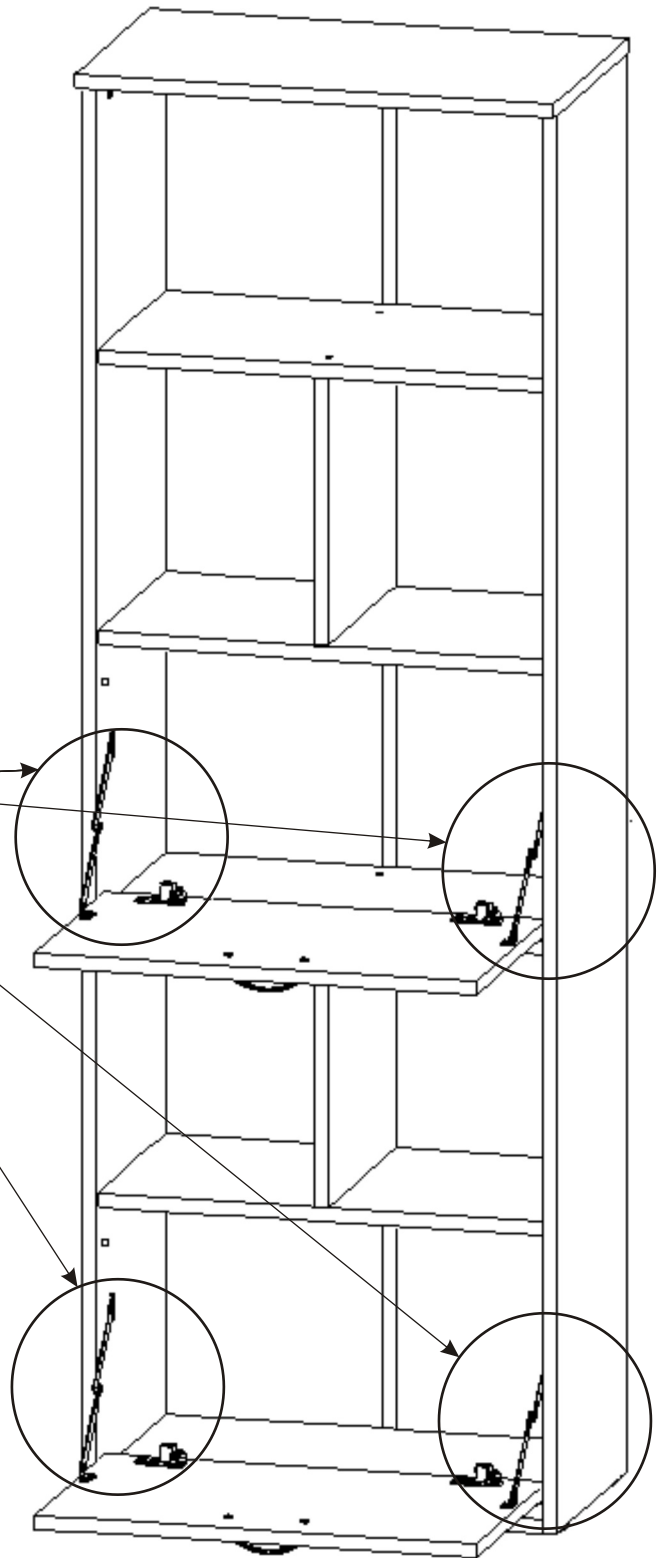
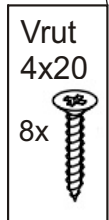
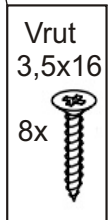
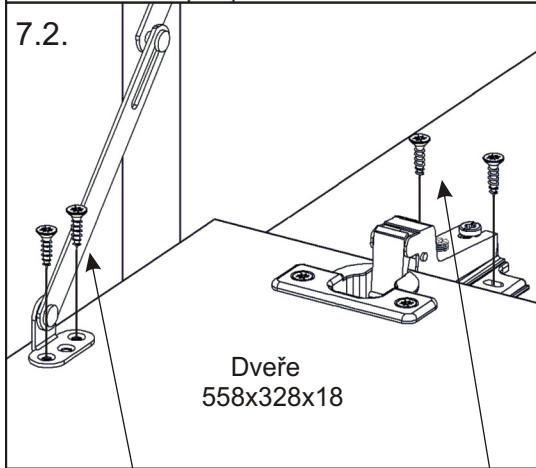
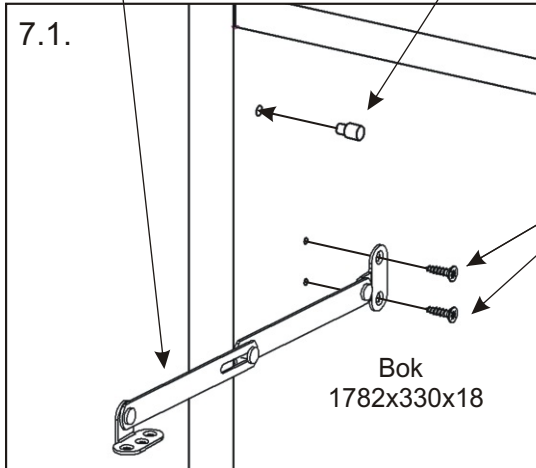
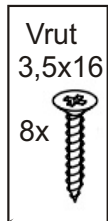
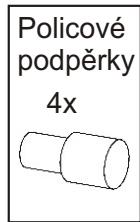
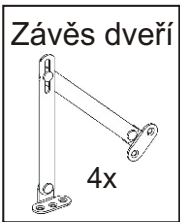

8.

Skříň doporučujeme kvůli nebezpečí převržení připevnit ke zdi pomocí úhelníků. Skříň přisuneme ke zdi na místo kde bude umístěna a naznačíme otvory pro hmoždinky. Navrtáme otvory pro hmoždinky a připevníme dodanými vruty. (Námi dodávané hmoždinky jsou vhodné pro stěny z plných materiálů.)

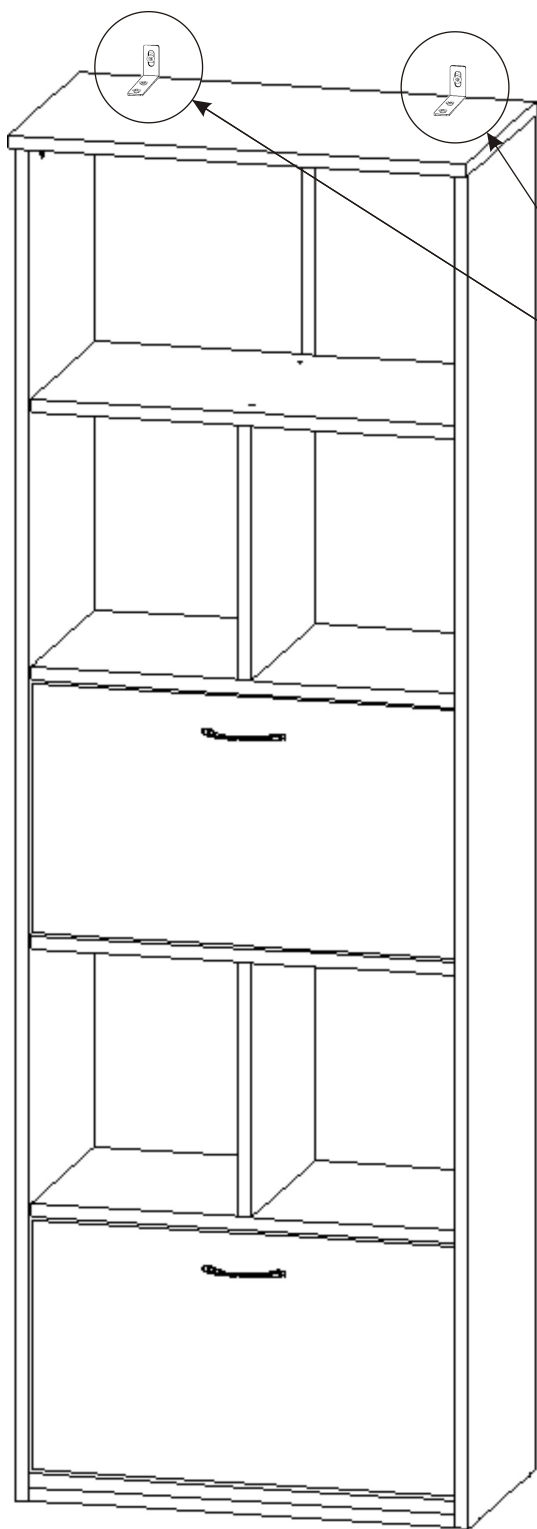

8.1.

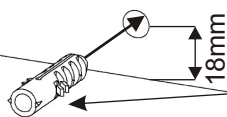

Hmoždinka

ø10

2x

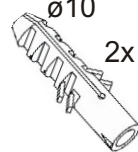

8.2.

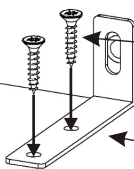

Vrut  
4x20

4x



8.3.

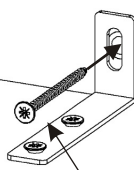

Úhelník  
73x31x15

2x

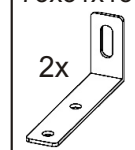

Vrut  
5x50

2x

